

# EPSON

ROBOT CONTROLLER / Drive Unit

*RC620DU*

Rev.3

EM105C2024F

ROBOT CONTROLLER / Drive Unit

RC620DU Rev.3

ROBOT CONTROLLER / DRIVE UNIT

# *RC620DU*

Rev.3

Copyright © 2009-2010 SEIKO EPSON CORPORATION. All rights reserved.

# FOREWORD

Thank you for purchasing our robot products.

This manual contains the information necessary for the correct use of the robot controller / Drive Unit.

Please carefully read this manual and other related manuals before installing the robot system.

Keep this manual handy for easy access at all times.

RC620 robot controller consists of the following:

- RC620 CU (Control Unit)

- RC620 DU (Drive Unit)

This manual contains the information for the RC620 DU (Drive Unit).

For RC620 CU (Control Unit), refer to the *RC620 Robot Controller* manual.

The information for the robot controller is describes as below, indicating both RC620 CU and RC620 DU:

- Robot controller

- Controller

- RC620

The information for the either unit (CU or DU) is described as below:

- RC620CU Control Unit

- RC620DU Drive Unit

# WARRANTY

The robot system and its optional parts are shipped to our customers only after being subjected to the strictest quality controls, tests, and inspections to certify its compliance with our high performance standards.

Product malfunctions resulting from normal handling or operation will be repaired free of charge during the normal warranty period. (Please ask your Regional Sales Office for warranty period information.)

However, customers will be charged for repairs in the following cases (even if they occur during the warranty period):

1. Damage or malfunction caused by improper use which is not described in the manual, or careless use.
2. Malfunctions caused by customers' unauthorized disassembly.
3. Damage due to improper adjustments or unauthorized repair attempts.
4. Damage caused by natural disasters such as earthquake, flood, etc.

Warnings, Cautions, Usage:

1. If the robot system associated equipment is used outside of the usage conditions and product specifications described in the manuals, this warranty is void.
2. If you do not follow the WARNINGS and CAUTIONS in this manual, we cannot be responsible for any malfunction or accident, even if the result is injury or death.
3. We cannot foresee all possible dangers and consequences. Therefore, this manual cannot warn the user of all possible hazards.

## TRADEMARKS

Microsoft, Windows, and Windows logo are either registered trademarks or trademarks of Microsoft Corporation in the United States and/or other countries. Other brand and product names are trademarks or registered trademarks of the respective holders.

## TRADEMARK NOTATION IN THIS MANUAL

Microsoft® Windows® XP Operating system

Throughout this manual, Windows XP or windows refer to above operating systems.

## NOTICE

No part of this manual may be copied or reproduced without authorization.

The contents of this manual are subject to change without notice.

Please notify us if you should find any errors in this manual or if you have any comments regarding its contents.

## INQUIRIES

Contact the following service center for robot repairs, inspections or adjustments.

If service center information is not indicated below, please contact the supplier office for your region.

Please prepare the following items before you contact us.

- Your Drive unit model and its serial number
- Your manipulator model and its serial number
- Software and its version in your robot system
- A description of the problem

## SERVICE CENTER

## MANUFACTURER & SUPPLIER

Japan & Others

**SEIKO EPSON CORPORATION**

Suwa Minami Plant

Factory Automation Systems Dept.

1010 Fujimi, Fujimi-machi,

Suwa-gun, Nagano, 399-0295

JAPAN

TEL : +81-(0)266-61-1802

FAX : +81-(0)266-61-1846

## SUPPLIERS

North & South America **EPSON AMERICA, INC.**

Factory Automation/Robotics

18300 Central Avenue

Carson, CA 90746

USA

TEL : +1-562-290-5900

FAX : +1-562-290-5999

E-MAIL : [info@robots.epson.com](mailto:info@robots.epson.com)

Europe

**EPSON DEUTSCHLAND GmbH**

Factory Automation Division

Otto-Hahn-Str.4

D-40670 Meerbusch

Germany

TEL : +49-(0)-2159-538-1391

FAX : +49-(0)-2159-538-3170

E-MAIL : [robot.infos@epson.de](mailto:robot.infos@epson.de)





---

# TABLE OF CONTENTS

---

## Safety

<b>1. Safety</b>	<b>3</b>
<b>2. Conventions</b>	<b>3</b>
<b>3. Safety Precautions</b>	<b>4</b>

## Setup & Operation

<b>1. Specifications</b>	<b>9</b>
1.1 System Example .....	9
1.2 Drive unit Standard Specifications .....	10
1.3 Outer Dimensions .....	11
<b>2. Part Names and Functions</b>	<b>12</b>
2.1 Part Names .....	12
2.2 Functions .....	13
2.3 LED .....	15
2.4 Safety Features .....	16
<b>3. Installation</b>	<b>18</b>
3.1 Unpacking .....	18
3.2 Environmental Requirements .....	18
3.2.1 Environment .....	18
3.2.2 Installation .....	19
3.2.3 Install inside the Cabinet .....	21
3.3 Power Supply .....	22
3.3.1 Specifications .....	22
3.3.2 AC Power Cable .....	23
3.4 Cable Connection .....	23
3.4.1 Typical Cable Connection .....	24
3.4.2 Connecting Manipulator to Drive unit .....	25
3.5 Noise Countermeasures .....	26
<b>4. Drive Unit Connection</b>	<b>27</b>
<b>5. Drive Unit Confirmation</b>	<b>28</b>

**6. EMERGENCY 29**

6.1 Safety Door Switch and Latch Release Switch..... 29

    6.1.1 Safety Door Switch ..... 29

    6.1.2 Latch Release Switch ..... 30

    6.1.3 Checking Latch Release Switch Operation ..... 30

6.2 Emergency Stop Switch Connection ..... 32

    6.2.1 Emergency Stop Switch ..... 32

    6.2.2 Checking Emergency Stop Switch Operation ..... 32

    6.2.3 Recovery from Emergency Stop..... 32

6.3 Pin Assignments..... 33

6.4 Circuit and Wiring Example ..... 34

    6.4.1 Circuit Diagrams ..... 34

    6.4.2 Wiring Example for Emergency Stop ..... 35

    6.4.3 Wiring Example for Safety Door Input / Latch Release Input.... 37

**7. I/O Connector 38**

7.1 Input Circuit ..... 38

7.2 Output Circuit ..... 40

7.3 Pin Assignment ..... 42

**Maintenance**

**1. Safety Precautions on Maintenance 45**

1.1 Safety Precautions ..... 45

1.2 Lockout / Tagout..... 46

**2. Regular Maintenance Inspection 47**

2.1 Schedule for Maintenance Inspection ..... 47

2.2 Inspection Point..... 47

    2.2.1 Inspection While the Drive unit is Turned OFF ..... 47

    2.2.2 Inspection While the Drive unit is Turned ON..... 47

**3. Drive unit Structure 48**

3.1 Location of Parts ..... 48

3.2 Diagram of Cable Connections..... 50

3.3 Connector Pin Assignment..... 53

    3.3.1 M/C Power Connector ..... 53

    3.3.2 M/C Signal Connector ..... 54

---

<b>4. Maintenance Parts Replacement Procedures</b>	<b>55</b>
4.1 Fan and Fan Filter.....	56
4.1.1 Cleaning and Replacing Fan Filter.....	56
4.1.2 Replacing Fan Unit.....	57
4.2 Motor Driver.....	59
4.2.1 Part Names.....	59
4.2.2 Replacing Motor Driver (Axis from 1 to 4).....	59
4.2.3 Replacing Motor Driver (Axis 5 and 6).....	64
4.3 SMB Unit.....	66
<b>5. Checklist for Contact</b>	<b>69</b>
<b>6. Maintenance Parts List</b>	<b>71</b>



# Safety

This section contains information for safety of the Robot System.



## 1. Safety



Installation and transportation of robots and robotic equipment shall be performed by qualified personnel and should conform to all national and local codes.

Please read this manual and other related manuals before installing the robot system or before connecting cables. Keep this manual in a handy location for easy access at all times.

Read the Safety chapter in *EPSON RC+ 5.0 User's Guide* and confirm *Safety-related requirements*.

## 2. Conventions

Important safety considerations are indicated throughout the manual by the following symbols. Be sure to read the descriptions shown with each symbol.

 WARNING	This symbol indicates that a danger of possible serious injury or death exists if the associated instructions are not followed properly.
 WARNING	This symbol indicates that a danger of possible harm to people caused by electric shock exists if the associated instructions are not followed properly.
 CAUTION	This symbol indicates that a danger of possible harm to people or physical damage to equipment and facilities exists if the associated instructions are not followed properly.

### 3. Safety Precautions

Only trained personnel should design and install the robot system.

Trained personnel are defined as those who have taken robot system training class held by the manufacturer, dealer, or local representative company, or those who understand the manuals thoroughly and have the same knowledge and skill level as those who have completed the training courses.

The following items are safety precautions for qualified design or installation personnel:

 WARNING	<ul style="list-style-type: none"><li>■ Personnel who design and/or construct the robot system with this product must read the Safety chapter in User's Guide to understand the safety requirements before designing and/or constructing the robot system. Designing and/or constructing the robot system without understanding the safety requirements is extremely hazardous, may result in serious bodily injury and/or severe equipment damage to the robot system, and may cause serious safety problems.</li><li>■ The Manipulator and the Drive unit must be used within the environmental conditions described in their respective manuals. This product has been designed and manufactured strictly for use in a normal indoor environment. Using the product in an environment that exceeds the specified environmental conditions may not only shorten the life cycle of the product but may also cause serious safety problems.</li><li>■ The robot system must be used within the installation requirements described in the manuals. Using the robot system outside of the installation requirements may not only shorten the life cycle of the product but also cause serious safety problems.</li><li>■ The interlock of the Safety Door must be functioning when the robot system is operated. Do not operate the system under the condition that the switch cannot be turned ON/OFF. (I.E. the condition where the switch is disabled) (Example: Tape is put around the switch to hold it closed.) Operating the robot system when the switch is not functioning properly is extremely hazardous and may cause serious safety problems as the Safety Door input cannot fulfill its intended function.</li><li>■ Connect input signal wires for Emergency Stop and Safety Door to the EMERGENCY connector so that the Emergency Stop switch in the whole system always functions. (Refer to the typical application diagram in <i>Setup &amp; Operation 6.4 Circuit and Wiring.</i>)</li></ul>
--	---



 <p>WARNING</p>	<ul style="list-style-type: none"> <li>■ Do not open the cover(s) of the Drive unit except while maintaining it. Opening the cover(s) of the Drive unit is extremely hazardous and may result in electric shock even when its main power is OFF because of the high voltage charge inside the Drive unit.</li> <li>■ Make sure that the power to the Drive unit is turned OFF before connecting or disconnecting any cables. Connecting or disconnecting any cables with the power ON is extremely hazardous and may result in electric shock and/or malfunction of the Drive unit.</li> <li>■ Be sure to connect the cables properly. Do not allow unnecessary strain on the cables. (Do not put heavy objects on the cables. Do not bend or pull the cables forcibly.) The unnecessary strain on the cables may result in damage to the cables, disconnection, and/or contact failure. Damaged cables, disconnection, or a contact failure is extremely hazardous and may result in electric shock and/or improper function of the system.</li> <li>■ When connecting the plug to fit the outlet in your factory, make sure that it is done by qualified personnel. When connecting the plug, be sure to connect the earth wire of the AC power cable colored green/yellow on the Drive unit to the earth terminal of the factory power supply. The equipment must be grounded properly at all times to avoid the risk of electric shock. Always use a power plug and receptacle. Never connect the Drive unit directly to the factory power supply. (Field wiring)</li> </ul>
--	--

 <p>CAUTION</p>	<ul style="list-style-type: none"> <li>■ The serial number of the Manipulator that should be connected is indicated on the Connection Check Label on the Drive unit. Connect the Drive unit and the Manipulator correctly. Improper connection between the Drive unit and the Manipulator may cause improper function of the robot system and also safety problems.</li> </ul>
--	--

The following items are safety precautions for qualified operator personnel:

 <p>WARNING</p>	<ul style="list-style-type: none"> <li>■ The interlock of the Safety Door must be functioning when the robot system is operated. Do not operate the system under the condition that the switch cannot be turned ON/OFF. (I.E. the condition where the switch is disabled) (Example: Tape is put around the switch to hold it closed.) Operating the robot system when the switch is not functioning properly is extremely hazardous and may cause serious safety problems as the Safety Door input cannot fulfill its intended function.</li> </ul>
--	---

 <p>WARNING</p>	<ul style="list-style-type: none"> <li>■ Do not open the cover(s) of the Drive unit except while maintaining it. Opening the cover(s) of the Drive unit is extremely hazardous and may result in electric shock even when its main power is OFF because of the high voltage charge inside the Drive unit.</li> </ul>
--	--



# Setup & Operation

This section contains information for setup and operation of the Drive Unit.



# 1. Specifications

## 1.1 System Example

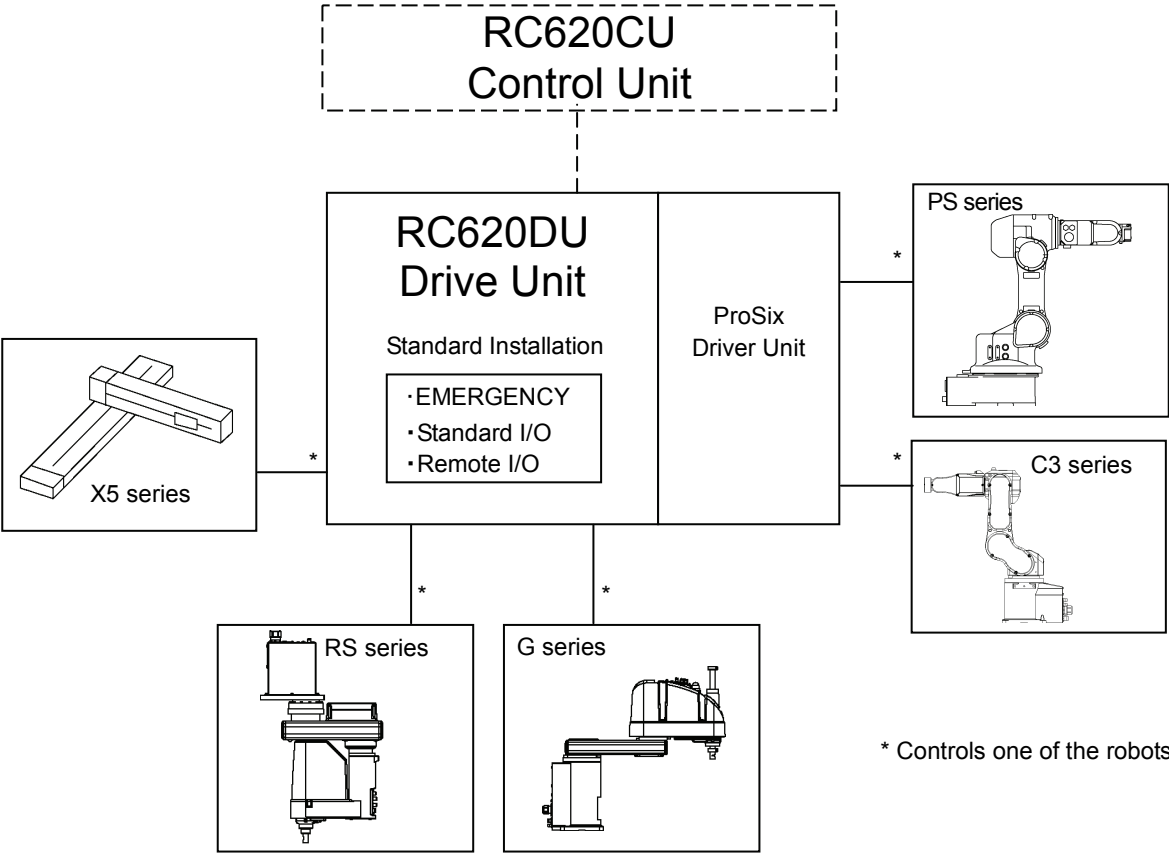

**NOTE** Drive Unit is the auxiliary unit connected with the control unit using the special cable.  
 Drive Unit cannot operate alone.  
 One or Two Drive Unit(s) can be used per robot system.

## 1.2 Drive Unit Standard Specifications

Item	Specification		
Model	Drive Unit RC620DU (UL specification: RC620DU-UL)		
Controllable axes	Up to six (6) connectable AC servo motors		
External input/output signals (standard)	Standard I/O	Input : 24 Output : 16	per Drive Unit
Drive Unit connect interface (standard)	2 channel		
Safety features	<ul style="list-style-type: none"> <li>- Emergency stop switch</li> <li>- Safety door input</li> <li>- Low power mode</li> <li>- Dynamic brake</li> <li>- Encoder cable disconnection error detection</li> <li>- Motor overload detection</li> <li>- Irregular motor torque (out-of-control Manipulator) detection</li> <li>- Motor speed error detection</li> <li>- Positioning overflow - servo error - detection</li> <li>- Speed overflow - servo error - detection</li> <li>- CPU irregularity detection</li> <li>- Memory check-sum error detection</li> <li>- Overheat detection at the Motor Driver Module</li> <li>- Relay welding detection</li> <li>- Over-voltage detection</li> <li>- AC power supply voltage reduction detection</li> <li>- Temperature error detection</li> <li>- Fan error detection</li> </ul>		
Power Source	AC 200 V to AC 240 V Single phase 50/60 Hz		
Maximum Power Consumption	2.5 kVA (Depending on the Manipulator model)		
Insulation Resistance	100 MΩ or more		
Rated Ambient Temperature	5 to 40 deg.C		
Rated Relative Humidity	20% to 80% (with no condensation)		
Weight *1	4 axes spec : 9 kg		
	6 axes spec : 10.5 kg		

\*1 Weight of the unit is indicated on the Drive Unit itself.

Make sure to check the weight before units transfer or relocation and prevent throwing out your back at holding the unit.

Also, make sure to keep your hands, fingers, and feet safe from being caught or serious injury.

# 1.3 Outer Dimensions

[Unit : mm]

## Base Unit (Four-axis robot construction)

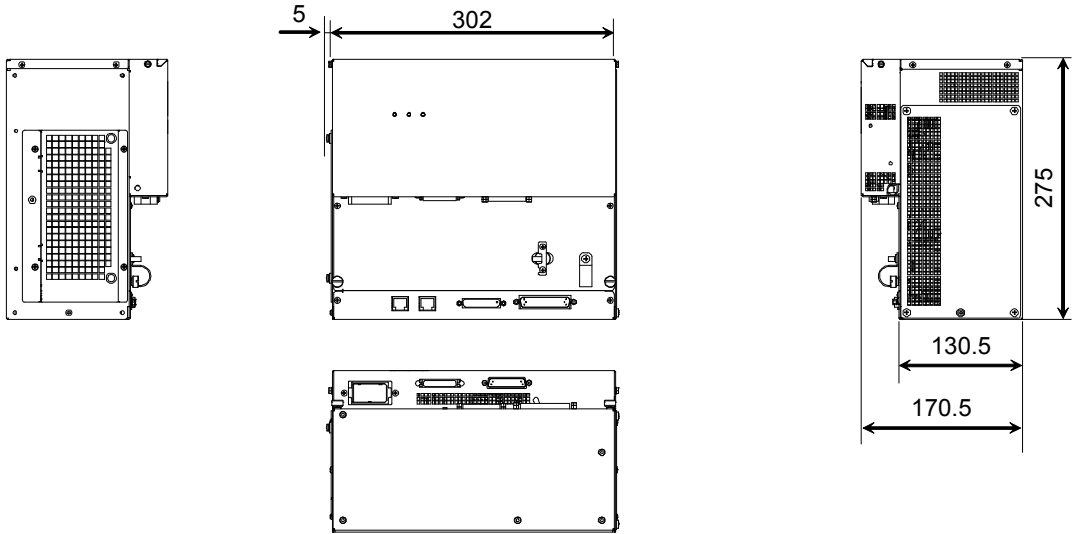

## Base Unit + ProSix Driver Unit (Six-axis robot construction)

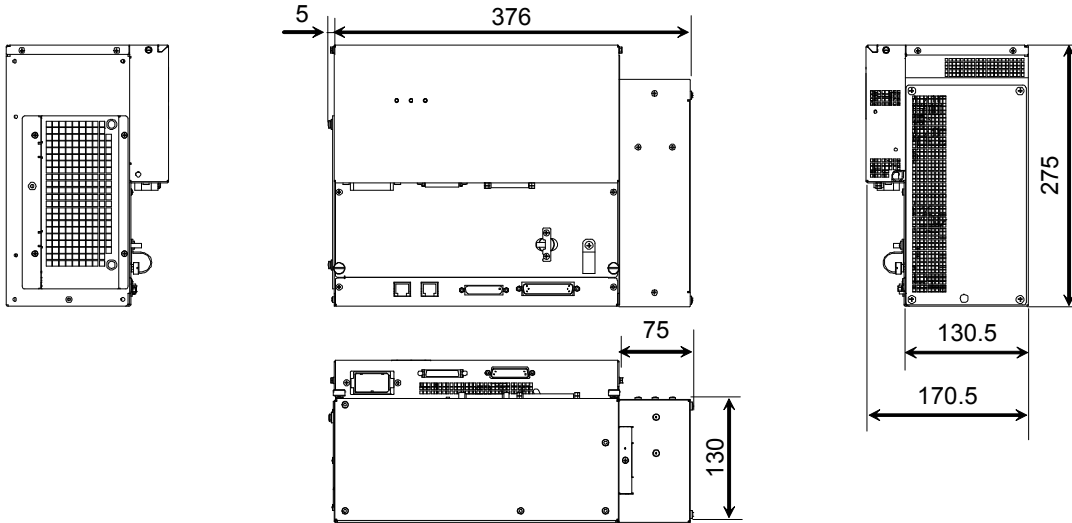

NOTE  

Dimension of RC620DU-UL is the same as RC620DU.

## 2. Part Names and Functions

### 2.1 Part Names

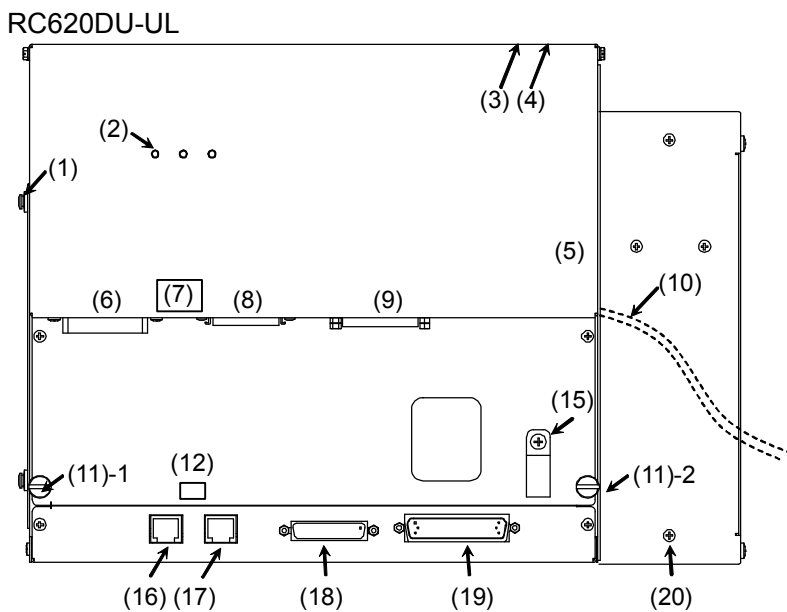
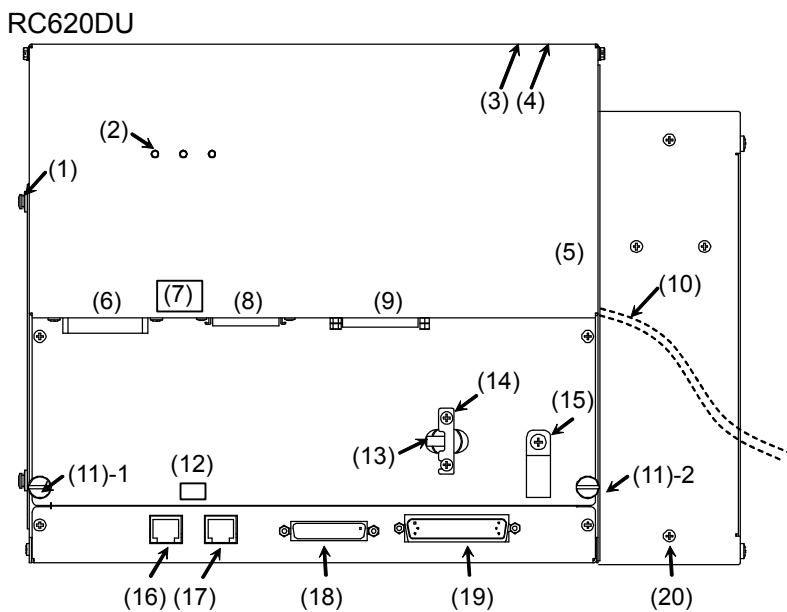



## 2.2 Functions

### (1) Fan Filter

A protective filter is installed in front of the fan to filter out dust.

Check the condition of the filter regularly and clean it when necessary. A dirty filter may result in malfunction of the robot system due to temperature rise of the Drive Unit.

For inspection, cleaning, and replacement, refer to the *Maintenance 4.1 Fan and Fan Filter*.

### (2) LED

The LED indicates current operation mode (RUN, AUTO, ERROR/E-STOP).

For details, refer to *Setup & Operation 2.3 LED*.

### (3) Signature label (top panel)

The serial number of the Drive Unit and other information are shown.

### (4) MT label (top panel)

The label indicates the specification number for the customized Manipulator and is attached only to the customized Manipulator. If your Manipulator indicates this label, it may require a specific maintenance procedure. In this case, make sure to contact your dealer before performing any maintenance procedures.

### (5) Drive Unit Number label

The serial number of the Drive Unit is indicated.

### (6) M/C POWER connector

A connector for the Manipulator power source.

Connect the dedicated power cable attached to the Manipulator.

### (7) Connection Check label

The details of the Manipulator to be connected are recorded on the label as shown in the right. The label indicates the Manipulator model and Manipulator serial number.

MANIPULATOR	
G6-551S	00002

### (8) M/C SIGNAL connector

This connector is used for signals such as the Manipulator's motor encoders, etc. Connect the Manipulator's dedicated signal cable.

### (9) EMERGENCY connector

This connector is used for input/output from/to Emergency Stop and Safety Door switches. For details, refer to the *Setup & Operation 6. EMERGENCY*.

### (10) AC IN

The cable for AC 200V power input.

For details, refer to *Setup & Operation 3.3.2 AC Power Cable*.

### (11) Thumb Head screw

This is two of the four screws used to attach the front cover of the Drive Unit. Use these screws to pull out the Motor Driver module and SMB unit.

#### NOTE



- A spacer is attached to the thumb head screw. Do not remove the spacer.

Installing the front cover using a thumb head screw without a spacer may result in a

cable being stuck and/or malfunction of the Drive Unit.

- Installing the front cover using other screws may result in cable being stuck and/or malfunction of the Drive Unit.

(12) DU number label

The label indicates the Drive Unit number (DU1 or DU2).

(13) POWER switch

Turns ON or OFF the Drive Unit.

- \* This is not available for RC620DU-UL. For details, refer to the *Setup & Operation 3.3.2 AC Power Cable, For RC620DU-UL*.

(14) Power Switch metal hasp

To lock the power switch in the OFF position, set the power switch to the OFF position and mount the metal hasp. Lock the power off for maintenance or repair of the robot system.

- \* This is not available for RC620DU-UL. For details, refer to the *Setup & Operation 3.3.2 AC Power Cable, For RC620DU-UL*.

(15) Cable Clamp

This can be used to secure the M/C Signal Cable and the EMERGENCY cable if necessary.

(16) DU OUT Connector

To connect the 2<sup>nd</sup> Drive Unit:

Use the cable attached for Drive Unit and connect with the DU IN connector of the 2<sup>nd</sup> Drive Unit.

(17) DU IN Connector

For the 1<sup>st</sup> Drive Unit:

Use the cable attached for Drive Unit and connect with the DU OUT connector of the Control Unit.

For the 2<sup>nd</sup> Drive Unit:

Use the cable attached for Drive Unit and connect with the DU OUT connector of the 1<sup>st</sup> Control Unit.

(18) R-I/O Connector

This connector is for the additional I/O function in the future.

It currently supports nothing and do not connect anything.

(19) I/O connector

This connector is used for input/output device. There are 24 inputs and 16 outputs.

For details, refer to *Setup & Operation 7. I/O Connector*.

(20) ProSix Driver Unit

This unit is used for PS series manipulator, C3 series manipulator.

Motor driver for two axes is installed.

## 2.3 LED

Three LEDs are mounted on Drive Unit. They have the following status patterns.

LED	Color	Status
RUN	Green	ON / Flashing / OFF
AUTO	Green	ON / OFF
ERR/E-STOP	Red	ON / Flashing / OFF

From applying current to Drive Unit to completing startup

	DU LED			DU IN connector
	RUN	AUTO	ERR/E-STOP	LINK (Green)
Power OFF	OFF	OFF	OFF	OFF
Power ON	Flashing	OFF	OFF	OFF
Establishing the connection	Flashing	OFF	OFF	Flashing rapidly
Normally operating	ON	OFF	OFF	Flashing rapidly

After the connection to Drive Unit is completed

LED	Status			
Auto mode	ON	ON	-	Flashing rapidly
Program mode	ON	OFF	-	Flashing rapidly
Teach mode	ON	OFF	-	Flashing rapidly
Robot error	ON	-	Flashing	Flashing rapidly
Emergency stop	ON	-	ON	Flashing rapidly

NOTE



The error information is displayed on the liquid crystal panel of Control Unit.

For details, refer to the *RC620 Robot Controller manual: Setup & Operation 2.3. LED and LCD*.

## 2.4 Safety Features

The robot control system supports safety features described below. However, the user is recommended to strictly follow the proper usage of the robot system by thoroughly reading the attached manuals before using the system. Failure to read and understand the proper usage of the safety functions is highly dangerous.

Among the following safety features, the Emergency Stop Switch and Safety Door Input are particularly important. Make sure that these and other features function properly before operating the robot system.

For details, refer to the Setup & Operation 6. EMERGENCY.

### Emergency Stop Switch

The EMERGENCY connector on the Drive Unit has expansion Emergency Stop input terminals used for connecting the Emergency Stop switches.

Pressing any Emergency Stop switch can shut off the motor power immediately and the robot system will enter the Emergency Stop condition.

### Safety Door Input

In order to activate this feature, make sure that the Safety Door Input switch is connected to the EMERGENCY connector at the Drive Unit.

When the safety door is opened, normally the Manipulator immediately stops the current operation, and the status of Manipulator power is operation-prohibited until the safety door is closed and the latched condition is released. In order to execute the Manipulator operation while the safety door is open, you must change the mode selector key switch on the Teach Pendant to the “Teach” mode. Manipulator operation is available only when the enable switch is on. In this case, the Manipulator is operated in low power status.

### Low Power Mode

The motor power is reduced in this mode.

Executing a power status change instruction will change to the restricted (low power) status regardless of conditions of the safety door or operation mode. The restricted (low power) status ensures the safety of the operator and reduces the possibility of peripheral equipment destruction or damage caused by careless operation.

### Dynamic Brake

The dynamic brake circuit includes relays that short the motor armatures. The dynamic brake circuit is activated when there is an Emergency Stop input or when any of the following errors is detected: encoder cable disconnection, motor overload, irregular motor torque, motor speed error, servo error (positioning or speed overflow), irregular CPU, memory check-sum error and overheat condition inside the Motor Driver Module.

### Encoder Cable Disconnection Error Detection

The dynamic brake circuit is activated when the Motor Encoder Signal cable is disconnected.

### Motor Overload Detection

The dynamic brake circuit is activated when the system detects that the load on the motor has exceeded its capacity.

#### Irregular Motor Torque (out-of-control manipulator) Detection

The dynamic brake circuit is activated when irregularity with motor torque (motor output) is detected (in which case the Manipulator is out of control).

#### Motor Speed Error Detection

The dynamic brake circuit is activated when the system detects that the motor is running at incorrect speed.

#### Positioning Overflow –Servo Error- Detection

The dynamic brake circuit is activated when the system detects that the difference between the Manipulator's actual position and commanded position exceeds the margin of error allowed.

#### Speed Overflow –Servo Error- Detection

The dynamic brake circuit is activated when the Manipulator's actual speed is detected to mark an overflow (the actual speed is outside the nominal range) error.

#### CPU Irregularity Detection

Irregularity of CPU that controls the motor is detected by the watchdog timer. The system CPU and the motor controlling CPU inside the Drive Unit are also designed to constantly check each other for any discrepancies. If a discrepancy is detected, the dynamic brake circuit is activated.

#### Memory Check-sum Error Detection

The dynamic brake circuit is activated when a memory check-sum error is detected.

#### Overheat Detection at the Motor Driver Module

The dynamic brake circuit is activated when the temperature of the power device inside the Motor Driver module is above the nominal limit.

#### Relay Deposition Detection

The dynamic brake circuit is activated when relay deposition or junction error is detected.

#### Over-Voltage Detection

The dynamic brake circuit is activated when the voltage of the Drive Unit is above the normal limit.

#### AC Power Supply Voltage Drop Detection

The dynamic brake circuit is activated when the drop of the power supply voltage is detected.

#### Temperature Anomaly Detection

The temperature anomaly is detected.

#### Fan Malfunction Detection

Malfunction of the fan rotation speed is detected.

## 3. Installation

### 3.1 Unpacking

- Controller mounting metal hasp (S) 1 set
- Controller mounting metal hasp (L) 1 set
- EMERGENCY port connector 1 set
- Connecting cable for RC620DU 1 cable

### 3.2 Environmental Requirements

 WARNING	<ul style="list-style-type: none"> <li>■ The Manipulator and the Drive Unit must be used within the environmental conditions described in their manuals. This product has been designed and manufactured strictly for use in a normal indoor environment. Using the product in the environment that exceeds the conditions may not only shorten the life cycle of the product but also cause serious safety problems.</li> </ul>
--	--

#### 3.2.1 Environment

In order to optimize the robot system’s performance for safety, the Drive Unit must be placed in an environment that satisfies the following conditions:

NOTE  

The Drive Unit is not designed for clean-room specification. If it must be installed in a clean room, be sure to install it in a proper enclosure with adequate ventilation and cooling.

NOTE  

Install Drive Unit in a location that allows easy connection / disconnection of cables.

Item	Condition
Ambient temperature	5 to 40 deg.C (with minimal variation)
Ambient relative humidity	20% to 80% (with no condensation)
First transient burst noise	2 kV or less (Power supply wire) 1 kV or less (Signal wire)
Electrostatic noise	4 kV or less
Base table	Use a base table that is at least 100 mm off the floor. Placing the Drive Unit directly on the floor could allow dust penetration leading to malfunction.

If the Drive Unit must be used in an environment that does not fulfill the conditions mentioned above, take adequate countermeasures. For example, the Drive Unit may be enclosed in a cabinet with adequate ventilation and cooling.

- Install indoors only.
- Place in a well-ventilated area.
- Keep away from direct sunlight and radiation heat.
- Keep away from dust, oily mist, oil, salinity, metal powder or other contaminants.
- Keep away from water.
- Keep away from shocks or vibrations.
- Keep away from sources of electronic noise
- Prevent the occurrence of strong electric or magnetic field.

### 3.2.2 Installation

- Mount the Drive Unit mounting screws with 80 to 110 Ncm torque.
- Install the Drive Unit on a flat surface such as wall, floor, and Drive Unit box in the direction shown from (A) to (D).

(A)

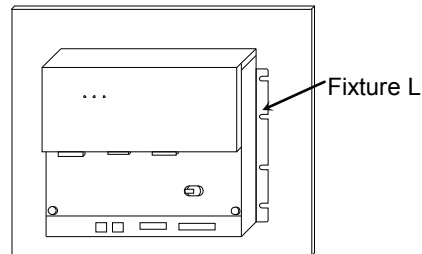

(B)

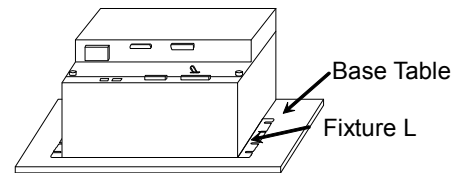

(C)

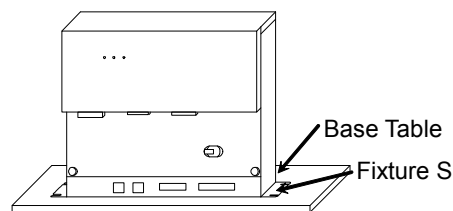

(D)

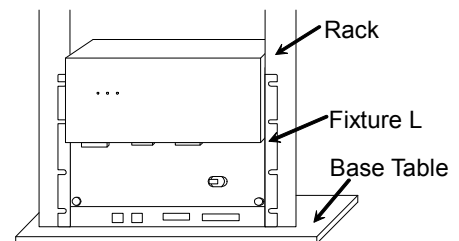

There are two types of fixtures. Mount the fixture to the Drive Unit with the four attached screws.

Fixture L: Used in (A), (B), and (D)

Fixture S: Used in I



The length from the edge of fixture L differs by the side. Refer to the following figure and mount the side with shorter distance from the edge to the screw hole on the Upper side.

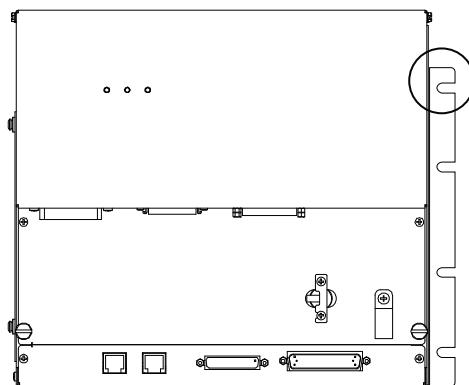

For Drive Unit installation to the Drive Unit box or the base table, process screw hole drilling as follows.

When mounting direction is (A) or (B)

Unit [mm]

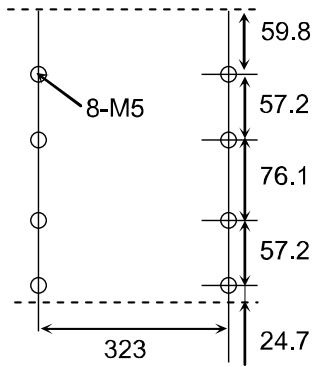

Drive unit only

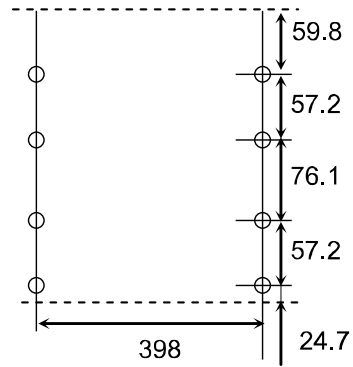

Drive unit + ProSix Driver Unit

When mounting direction is (C)

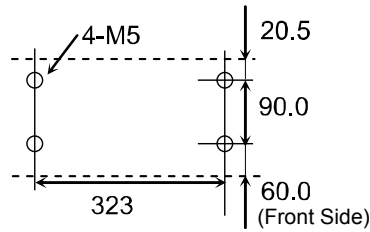

Drive unit only

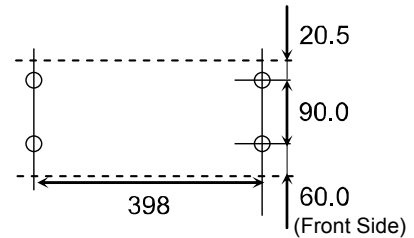

Drive unit + ProSix Driver Unit

No screw hole processing is required for mounting direction (D).  
Secure it to the rack with screws and nuts.

- Ensure the draft around the in/out and also install the Drive Unit by keeping the distance as follows to prevent the nose influence from other equipments such as large contactor and relay.

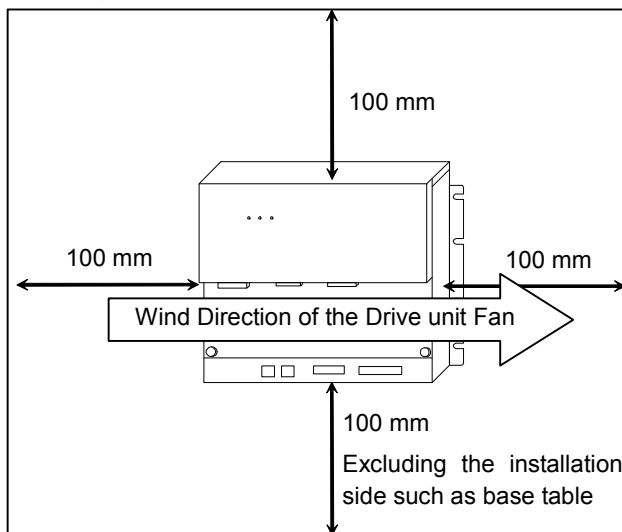

- Hot air with higher temperature than the ambient temperature (about 10 deg.C) comes out from the Drive Unit.

Make sure that heat sensitive devices are not placed near the outlet.



### 3.2.3 Install inside a Cabinet

When installing the Drive Unit inside a Cabinet, make sure to satisfy the condition indicated in 3.2.1 *Environment*, 3.2.2 *Installation* and also the following conditions.

- The distance from the mounting surface and the inside of the door must be 220 mm or more (190 mm when using the option I/O connector).

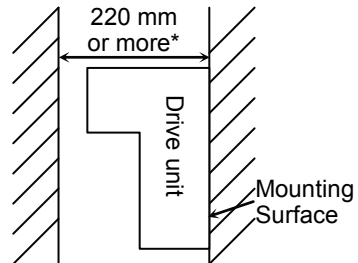

I/O Connector (Option)  
Product No: R12B040710

\* When using the I/O connector (option), 190 mm or more

- Set the temperature inside the Drive Unit box to 40 deg.C or less by referring the cooling method in the following example.

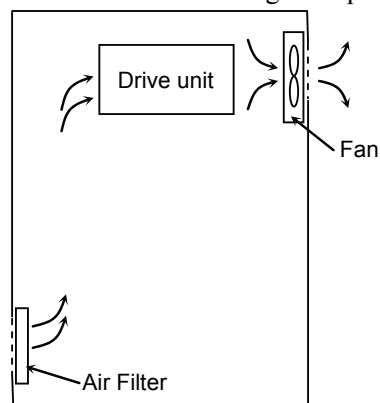

## 3.3 Power Supply

### 3.3.1 Specifications

Ensure that the available power meets following specifications.

Item	Specification
Voltage	AC 200 V to AC 240 V
Phase	Single phase
Frequency	50/60 Hz
Momentary Power Interrupt	10 msec. Or less
Power Consumption	Max. 2.5 kVA Actual consumption depends on the model, motion, and load of the Manipulator. Rated consumption $= ( 150 \text{ W} + \text{total Manipulator rated consumption} ) / 0.6$ The rated consumption for G10 and G20 is 2.5 kVA. Refer to Manipulator manual for Manipulator rated consumption.
Peak Current	When power is turned ON : approximately 150 A (2 msec.) When motor is ON : approximately 60 A (5 msec.)
Leakage Current	Max. 3.5 mA
Ground Resistance	100 $\Omega$ or less

Install an earth leakage circuit breaker or a circuit breaker in the AC power cable line at 15 A or less rated electric current. Both should be a two-pole disconnect type. If you install an earth leakage circuit breaker, make sure to use an inverter type that does not operate by induction of a 10 kHz or more leakage current. If you install a circuit breaker, please select one that will handle the above mentioned “peak current”.

The power receptacle shall be installed near the equipment and shall be easily accessible.

### 3.3.2 AC Power Cable

 WARNING	<ul style="list-style-type: none"> <li>Make sure that cable manufacturing and connection are done by a qualified personal. When proceeding, be sure to connect the earth wire of the AC power cable colored green/yellow on the Drive Unit to the earth terminal of the factory power supply. The equipment must be grounded properly at all times to avoid the risk of electric shock. Always use a power plug and receptacle for power connecting cable. Never connect the Drive Unit directly to the factory power supply. (Field wiring)</li> </ul>
--	---

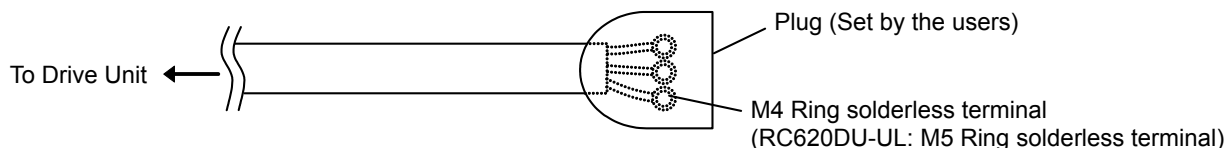

The AC plug is not attached to the AC power cable delivered at shipment. Refer to the wire connection specification and attach a proper plug to the cable that is suitable for the factory power supply. (A plug is prepared as option.)

#### Cable Wire Connection Specification

Purpose	Color
AC power wire (2 cables)	Black
Ground wire	Green / Yellow

Cable length : 3 mm (Standard)

For RC620DU-UL

 WARNING	<ul style="list-style-type: none"> <li>Branch Circuit protection (Rated current: 15 A or less) shall be installed in the external AC power supplying side in accordance with the National Electrical Code. A disconnecting means shall be installed in accordance with the National Electrical Code and provide the ability for lockout and tagout.</li> </ul>
--	--

## 3.4 Cable Connection

 WARNING	<ul style="list-style-type: none"> <li>Make sure that the power to the Drive Unit is turned OFF and the power plug is disconnected before connecting or disconnecting any cables. Connecting or disconnecting any cables with the power ON is extremely hazardous and may result in electric shock and malfunction of the Drive Unit.</li> <li>Be sure to connect the cables properly. Do not allow unnecessary strain on the cables. (Do not put heavy objects on the cables. Do not bend or pull the cables forcibly.) The unnecessary strain on the cables may result in damage to the cables, disconnection, and/or contact failure. Damaged cables, disconnection, or contact failure is extremely hazardous and may result in electric shock and/or improper function of the system.</li> </ul>
--	---

 CAUTION	<ul style="list-style-type: none"> <li>The serial number of the Manipulator that should be connected is indicated on the Connection Check Label on the Drive Unit. Connect the Drive Unit and the Manipulator correctly. Improper connection between the Drive Unit and the Manipulator may cause not only improper function of the robot system but also safety problems.</li> <li>Before connecting the connector, make sure that the pins are not bent. Connecting with the pins bent may damage the connector and result in malfunction of the robot system.</li> </ul>
--	---

### 3.4.1 Typical Cable Connection

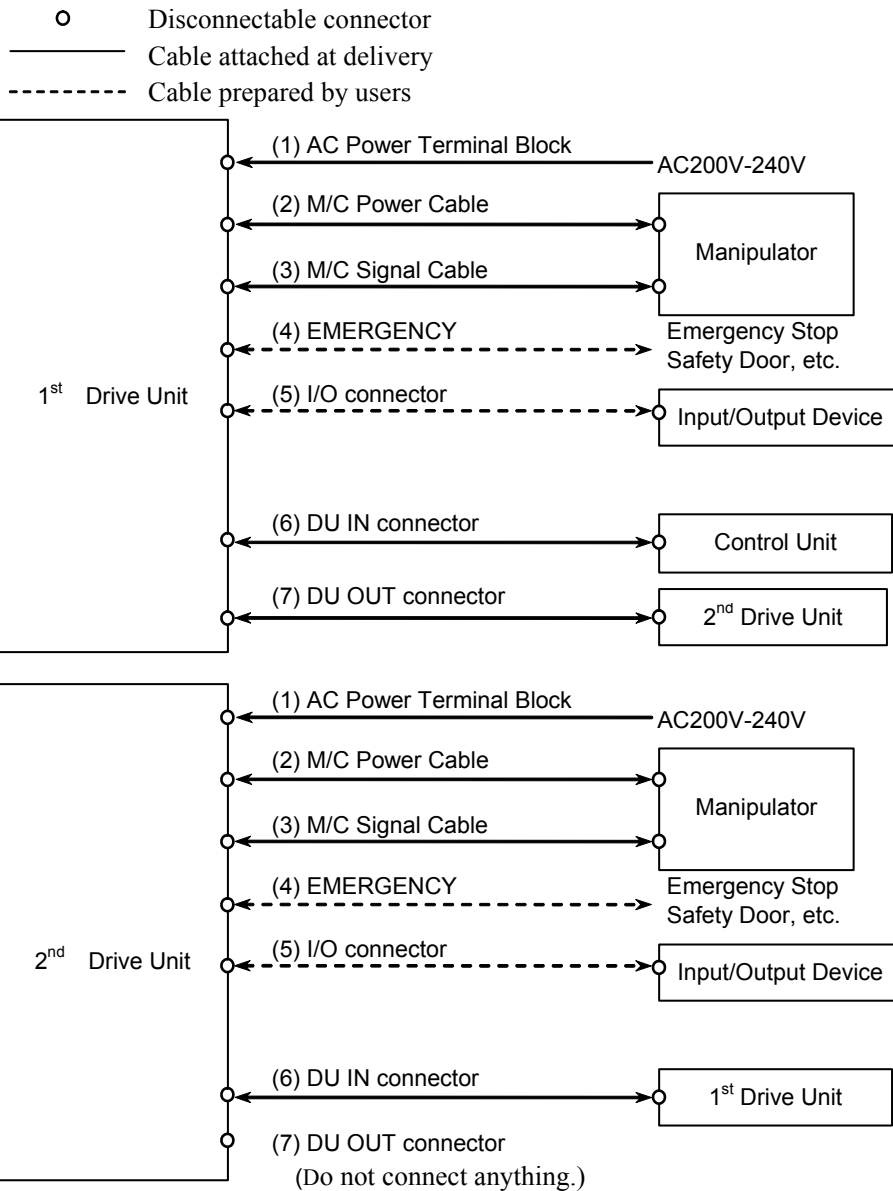

- (1) AC Power terminal block  
Terminal block for AC 200V power input to the Drive Unit.
- (2) M/C Power cable  
The cable with 50-pin connector on the Drive Unit side.  
Connect the POWER connector on the Manipulator and the M/C POWER connector on the Drive Unit. Insert the connectors until you hear a “click”.
- (3) M/C Signal cable  
The cable with 50-pin connector on the Drive Unit side.  
Connect the signal cable to the SIGNAL connector on the Manipulator and the M/C SIGNAL connector on the Drive Unit.

(4) EMERGENCY

The EMERGENCY connector has inputs to connect the Emergency Stop switch and the Safety Door switch. For safety reasons, connect proper switches for these input devices.

For details, refer to the *Setup & Operation 6. EMERGENCY*.

(5) I/O connector

This connector is used for input/output devices of the user.

When there are input/output devices, use this connector.

There are I/O cable (option) and terminal block (option) for the I/O connector.

For details, refer to the *Setup & Operation 7. I/O Connector*.

(6) DU IN connector

For the 1<sup>st</sup> Drive Unit:

Use the cable attached for Drive Unit and connect with the DU OUT connector of the Control Unit.

For the 2<sup>nd</sup> Drive Unit:

Use the cable attached for Drive Unit and connect with the DU OUT connector of the 1<sup>st</sup> Control Unit.

(7) DU OUT connector

To connect the 2<sup>nd</sup> Drive Unit:

Use the cable attached for Drive Unit and connect with the DU IN connector of the 2<sup>nd</sup> Drive Unit.

\* Be sure not to connect anything to this connector when using only one Drive Unit. Also, when using the 2<sup>nd</sup> Drive Unit, do not connect anything to this connector on the 2<sup>nd</sup> Drive Unit.

3.4.2 Connecting Manipulator to Drive Unit

Connect the Manipulator to the Drive Unit by using the Power cable and the Signal cable.

 WARNING	<ul style="list-style-type: none"> <li>■ Make sure that the power to the Drive Unit is turned OFF before connecting or disconnecting any cables. Connecting or disconnecting any cables with the power ON is extremely hazardous and may result in electric shock and malfunction of the Drive Unit.</li> <li>■ Be sure to connect the cables properly. Do not allow unnecessary strain on the cables. (Do not put heavy objects on the cables. Do not bend or pull the cables forcibly.) The unnecessary strain on the cables may result in damage to the cables, disconnection, and/or contact failure. Damaged cables, disconnection, or contact failure is extremely hazardous and may result in electric shock and/or improper function of the system.</li> </ul>
--	--

 CAUTION	<ul style="list-style-type: none"> <li>■ The serial number of the Manipulator that should be connected is indicated on the Drive Unit. Connect the Drive Unit and the Manipulator correctly. Improper connection between the Drive Unit and the Manipulator may cause not only improper function of the robot system but also serious safety problems.</li> </ul>
--	---

NOTE  The Manipulator's serial number is indicated on the signature label on the back of the Manipulator.

## 3.5 Noise Countermeasures

To minimize electrical noise conditions, the following items must be observed in the system's cable wiring:

To minimize electrical noise condition, be sure of followings for wiring.

- The earth wire of the power supply should be grounded. (Ground resistance: 100  $\Omega$  or less) It is important to ground the frame of Drive Unit not only for prevention from electric shock, but also for reducing the influence of electric noise around the Drive Unit. Therefore, be sure to connect the earth wire (yellow/green) of the Drive Unit's power cable to the ground terminal of the factory power supply. For details about the plug and AC power cable, refer to the *Setup & Operation 3.3 Power Supply*.
- Do not tap power from a power line that connects to any equipment which may cause noise.
- When you tap power for the Drive Unit and the single-phase AC motor from the same power line, change the phase of one or the other. Ensure that they will not be the same phase.
- Use a twisted pair motor power line.
- Do not run AC power lines and DC power lines in the same wiring duct, and separate them by at least 200 mm. For example, separate the AC motor power line and the Drive Unit power line by at least 200 mm from the sensor or valve I/O lines; and do not bundle both sets of wiring with the same cable tie. If more than one duct/cable must cross each other, they should cross perpendicularly. The preferable example is shown in the right figure.
- Wire as short as possible to the I/O connector and EMERGENCY connector. Use a shielded cable and clamp the shield to the attached connector interior. Make sure to keep away from the peripheral noise source as far as possible.
- Make sure that the induction elements used to connect to the Drive Unit's I/O (such as relays and solenoid valves) have surge suppressors. If an induction element without a surge suppressor is used, make sure to connect a rectifying diode located at the induction element in parallel with it. In selecting a rectifying diode, make sure that it can handle the voltage and current incurred by the induction load.
- To start and change revolutions of the conveyer's (or the like's) AC motor (ex: an induction motor or three-phase induction motor) regularly or abruptly, make sure to install a spark suppressor between the wires. The spark suppressor is more effective when placed closer to the motor.

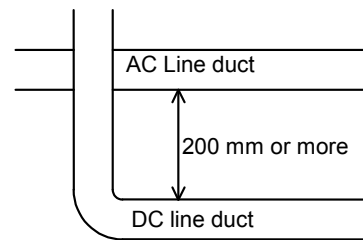

## 4. Drive Unit Connection

Drive Unit is connected to the Control Unit using the attached connection cable.  
Up to two Drive Units can be connected to the Control Unit.

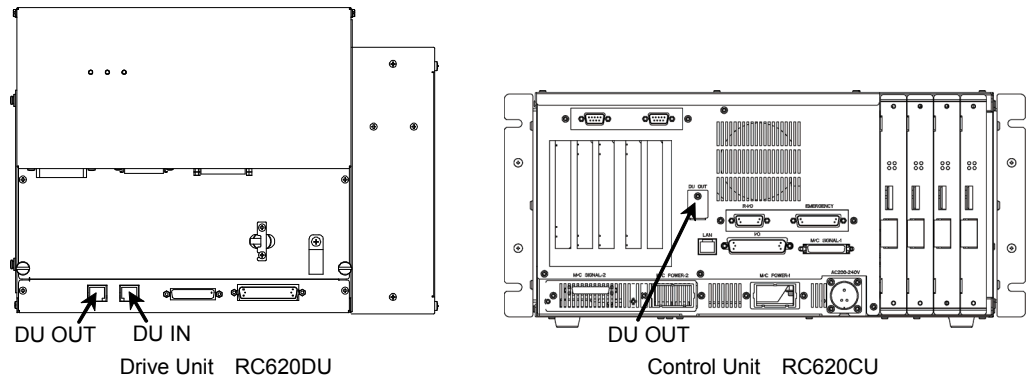

A: Control Unit and 1<sup>st</sup> Drive Unit (CU-DU1)

B: 1<sup>st</sup> Drive Unit and 2<sup>nd</sup> Drive Unit (DU1-DU2)

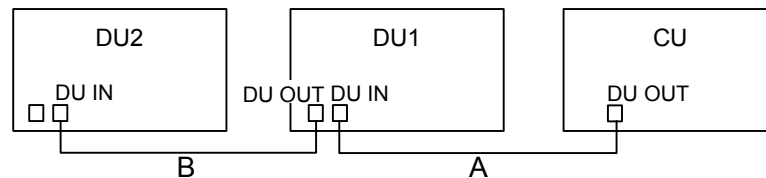

### NOTE



- When you use one Drive Unit:  
Connect nothing to DU OUT of the 1<sup>st</sup> Drive Unit (DU1). Otherwise, it results in the robot controller malfunction.

- When you use two Drive Units:  
Connect nothing to DU OUT of the 2<sup>nd</sup> Drive Unit (DU2). Otherwise, it results in the robot controller malfunction.

### NOTE



- Do not use any LAN cables on the market. Otherwise, it results in the robot controller malfunction.

How to turn on the power switch:

Check the connection first. Then, make sure to turn on the power switch of Drive Unit before turning on the power switch of Control Unit.

# 5. Drive Unit Confirmation

To confirm 1<sup>st</sup> or 2<sup>nd</sup> Drive Unit, use the following methods.

With DU number label:

Check the label attached on Drive Unit.

- DU1 : 1<sup>st</sup> Drive Unit
- DU2 : 2<sup>nd</sup> Drive Unit

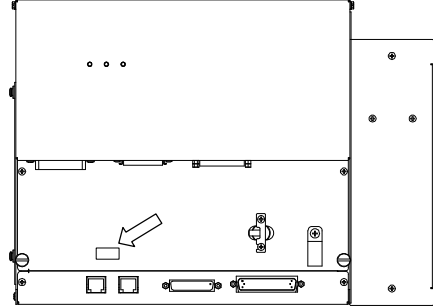

With SMB:

The DIP switch is equipped in SMB to configure 1<sup>st</sup> and 2<sup>nd</sup> Drive Unit.

Follow the steps below to confirm the Drive Unit.

- (1) Turn OFF the Drive Unit.
- (2) Pull out the two plastic fasteners indicated in the photo.

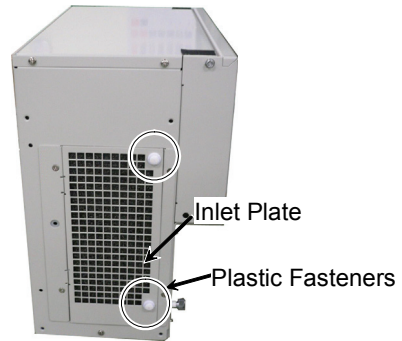

- (3) Change the DIP switch in SMB.

1<sup>st</sup> Drive Unit

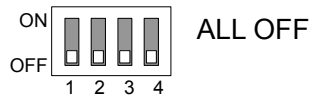

2<sup>nd</sup> Drive Unit

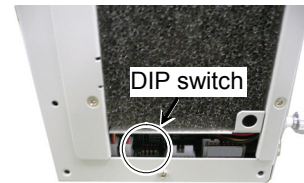

- (4) Insert the two flared parts of the inlet plate into the opening of the Drive Unit in the direction shown by arrow (a).
- (5) Push the two plastic fasteners in the direction shown by arrow (b) until they make a clicking sound to secure the inlet plate. Make sure that the plate is mounted properly.

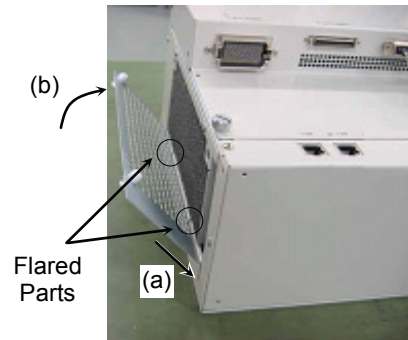

- (6) Plug in the power connector. Turn ON the Drive Unit.



## 6. EMERGENCY

**NOTE**  The details of safety requirements for this section are described in *EPSON RC+ 5.0 2. Safety*. Please refer to them to keep the robot system safe.

Connect a safeguard switch or Emergency Stop switch to the Drive Unit EMERGENCY connector for safety.

When nothing is connected to the EMERGENCY connector, the Drive Unit does not operate normally.

 <b>WARNING</b>	<ul style="list-style-type: none"> <li>Before connecting the connector, make sure that the pins are not bent. Connecting with the pins bent may damage the connector and result in malfunction of the robot system.</li> </ul>
---	--

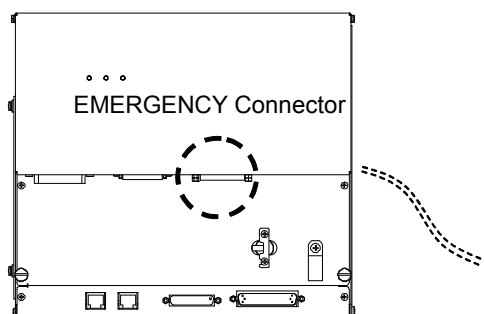

### 6.1 Safety Door Switch and Latch Release Switch

The EMERGENCY connector has input terminals for the Safety Door switch and the Emergency Stop switch. Be sure to use these input terminals to keep the system safe.

Connector	Standard
EMERGENCY connector (Drive Unit side)	D-sub 25 male pin Mounting style #4 - 40

\* The connector cable, terminal block, and connector kit are offered as options.

#### 6.1.1 Safety Door Switch

 <b>WARNING</b>	<ul style="list-style-type: none"> <li>The interlock of the Safety Door must be functioning when the robot system is operated. Do not operate the system under the condition that the switch cannot be turned ON/OFF (e.g. The tape is put around the switch.). Operating the robot system when the switch is not functioning properly is extremely hazardous and may cause serious safety problems as the Safety Door input cannot fulfill its intended function.</li> </ul>
---	---

In order to maintain a safe working zone, a safeguard must be erected around the Manipulator. The safeguard must have an interlock switch at the entrance to the working zone. The Safety Door that is described in this manual is one of the safeguards and an interlock of the Safety Door is called a Safety Door switch. Connect the Safety

Door switch to the Safety Door input terminal on the EMERGENCY connector.  
The Safety Door switch has safety features such as temporary hold-up of the program or the operation-prohibited status that are activated whenever the Safety Door is opened.

Observe the followings in designing the Safety Door switch and the Safety Door.

- For the Safety Door switch, select a switch that opens as the Safety Door opens, and not by the spring of the switch itself.
- The signal from the Safety Door (Safety Door input) is designed to input to two redundant signals. If the signals at the two inputs differ by two seconds or more, the system recognizes it to be a critical error. Therefore, make sure that the Safety Door switch has two separate redundant circuits and that each connects to the specified pins at the EMERGENCY connector on the Drive Unit.
- The Safety Door must be designed and installed so that it does not close accidentally.

### 6.1.2 Latch Release Switch

The software latches these conditions:

- The safety door is open.
- The operation mode is set to “TEACH”.

The EMERGENCY connector has an input terminal for a latch release switch that cancels the latched conditions.

Open : The latch release switch latches conditions that the safety door is open or the operation mode is “TEACH”.

Closed : The latch release switch releases the latched conditions.



When the latched TEACH mode is released while the safety door is open, the status of Manipulator power is operation-prohibited because the safety door is open at that time. To execute a Manipulator operation, close the safety door again, and then close the latch release input.

### 6.1.3 Checking Latch Release Switch Operation

After connecting the safety door switch and latch release switch to the EMERGENCY connector, be sure to check the switch operation for safety by following the procedures described below before operating the Manipulator.

- (1) Turn ON the Drive Unit while the safety door is open in order to boot the software.
- (2) Make sure that “Safety” is displayed on the main window status bar.
- (3) Close the safety door, and turn ON the switch connecting to the latch release input. Make sure that the “Safety” is dimmed on the status bar.

The information that the safety door is open can be latched by software based on the latch release input condition.

Open : The latch release switch latches the condition that the safety door is open.  
To cancel the condition, close the safety door, and then close the safety door latch release input.

Closed : The latch release switch does not latch the condition that the safety door is open.

NOTE



The latch release input also functions to acknowledge the change of to TEACH mode.  
In order to change the latched condition of TEACH mode, turn the mode selector key switch on the Teach Pendant to “Auto”. Then, close the latch release input.

## 6.2 Emergency Stop Switch Connection

### 6.2.1 Emergency Stop Switch

If it is desired to add an external Emergency Stop switch(es) in addition to the Emergency Stop on the Teach Pendant, be sure to connect such Emergency Stop switch(es) to the Emergency Stop input terminal on the EMERGENCY connector.

The Emergency Stop switch connected must comply with the following:

- It must be a push button switch that is “normally closed”.
- A button that does not automatically return or resume.
- The button must be mushroom-shaped and red.
- The button must have a double contact that is “normally closed”.

NOTE



The signal from the Emergency Stop switch is designed to use two redundant circuits. If the signals at the two circuits differ by two seconds or more, the system recognizes it as a critical error. Therefore, make sure that the Emergency Stop switch has double contacts and that each circuit connects to the specified pins on the EMERGENCY connector at the Drive Unit. Refer to the *Setup & Operation 6.4 Circuit and Wiring*.

### 6.2.2 Checking Emergency Stop Switch Operation

Once the Emergency Stop switch is connected to the EMERGENCY connector, continue the following procedure to make sure that the switch functions properly. For the safety of the operator, the Manipulator must not be powered ON until the following test is completed.

- (1) Turn ON the Drive Unit to boot the software while pressing the Emergency Stop switch.
- (2) Make sure that “ERROR/E-STOP” LED on Drive Unit has been turned ON.
- (3) Make sure that “E.Stop” is displayed on the main window status bar.
- (4) Release the Emergency Stop Switch.
- (5) Execute the RESET command.
- (6) Make sure that “ERROR/E-STOP” LED turns OFF and “E-Stop” display fades on the main window status bar.

### 6.2.3 Recovery from Emergency Stop

To recover from the emergency stop condition, follow the procedure of safety check as required by the system.

After safety check, the operations below are required to recover from the emergency stop condition.

- Release the Emergency Stop Switch
- Execute the RESET command

## 6.3 Pin Assignments

The EMERGENCY connector pin assignments are as follows:

Pin No.	Signal	Function	Pin No.	Signal	Function
1	ESW11	Emergency Stop switch contact (1) <sup>*3</sup>	14	ESW21	Emergency Stop switch contact (2) <sup>*3</sup>
2	ESW12	Emergency Stop switch contact (1) <sup>*3</sup>	15	ESW22	Emergency Stop switch contact (2) <sup>*3</sup>
3	ESTOP1+	Emergency Stop circuit 1 (+)	16	ESTOP2+	Emergency Stop circuit 2 (+)
4	ESTOP1-	Emergency Stop circuit 1 (-)	17	ESTOP2-	Emergency Stop circuit 2 (-)
5	NC	<sup>*1</sup>	18	SDLATCH1	Safety Door Latch Release
6	NC	<sup>*1</sup>	19	SDLATCH2	Safety Door Latch Release
7	SD11	Safety Door input (1) <sup>*2</sup>	20	SD21	Safety Door input (2) <sup>*2</sup>
8	SD12	Safety Door input (1) <sup>*2</sup>	21	SD22	Safety Door input (2) <sup>*2</sup>
9	24V	+24V output	22	24V	+24V output
10	24V	+24V output	23	24V	+24V output
11	24VGND	+24V GND output	24	24VGND	+24V GND output
12	24VGND	+24V GND output	25	24VGND	+24V GND output
13	NC				

\*1 Do not connect anything to these pins.

\*2 A critical error occurs if the input values from the Safety Door 1 and Safety Door 2 are different for two or more seconds. They must be connected to the same switch with two sets of contacts.

\*3 A critical error occurs if the input values from the Emergency Stop switch contact 1 and Emergency Stop switch contact 2 are different for two or more seconds. They must be connected the same switch with two sets of contacts.

Emergency Stop switch output rated load	+30 V 0.3 A or under	1-2, 14-15 pin
Emergency Stop rated input voltage range	+24 V $\pm 10\%$	3-4, 16-17 pin
Emergency Stop rated input current	47.5 mA/+24 V input	
Safety Door rated input voltage range	+24 V $\pm 10\%$	7-8, 20-21 pin
Safety Door rated input current	10 mA/+24 V input	
Latch Release rated input voltage range	+24 V $\pm 10\%$	18-19 pin
Latch Release rated input current	10 mA/+24 V input	

 **NOTE** The total electrical resistance of the Emergency Stop switches and their circuit should be 1  $\Omega$  or less.

# 6.4 Circuit and Wiring

## 6.4.1 Circuit Diagram

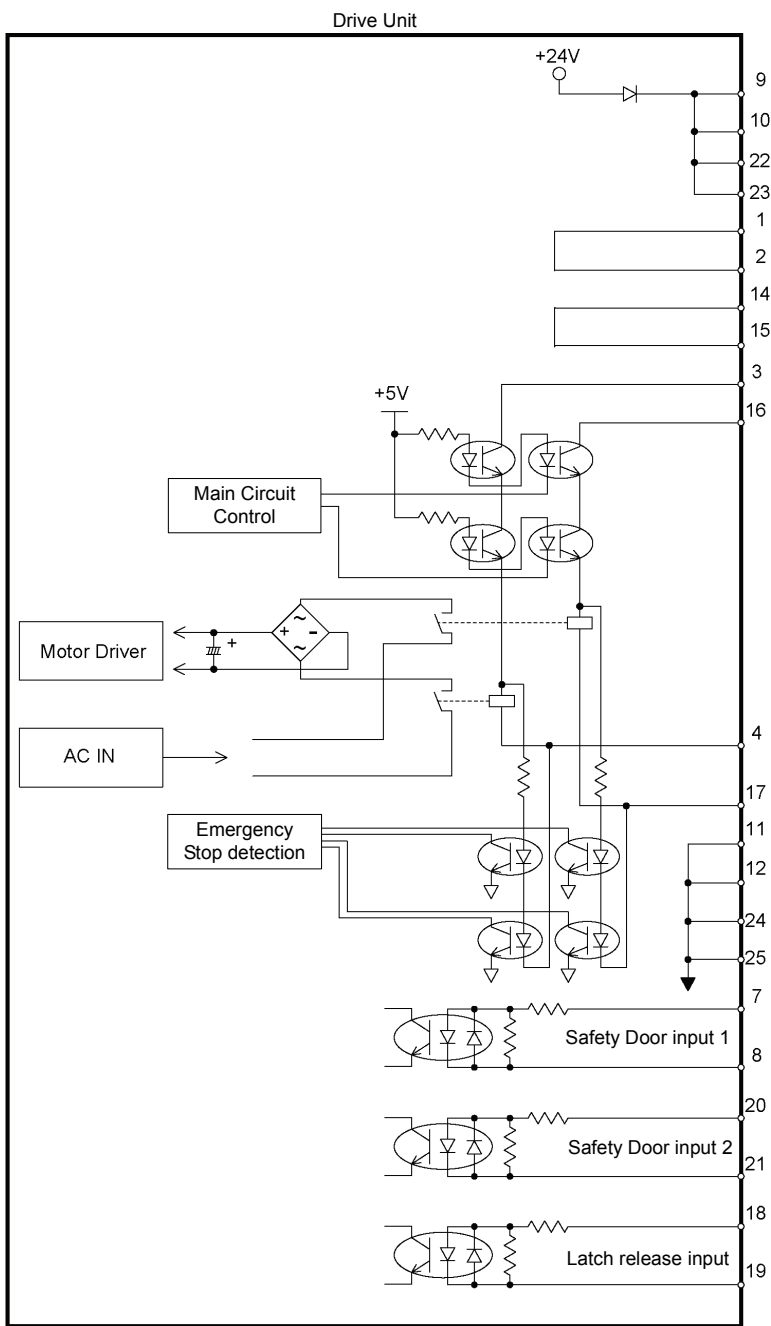

NOTE : +24V GND ▼  
 +5V GND ▽

6.4.2 Wiring Example for Emergency Stop

6.4.2.1 External emergency stop switch typical application

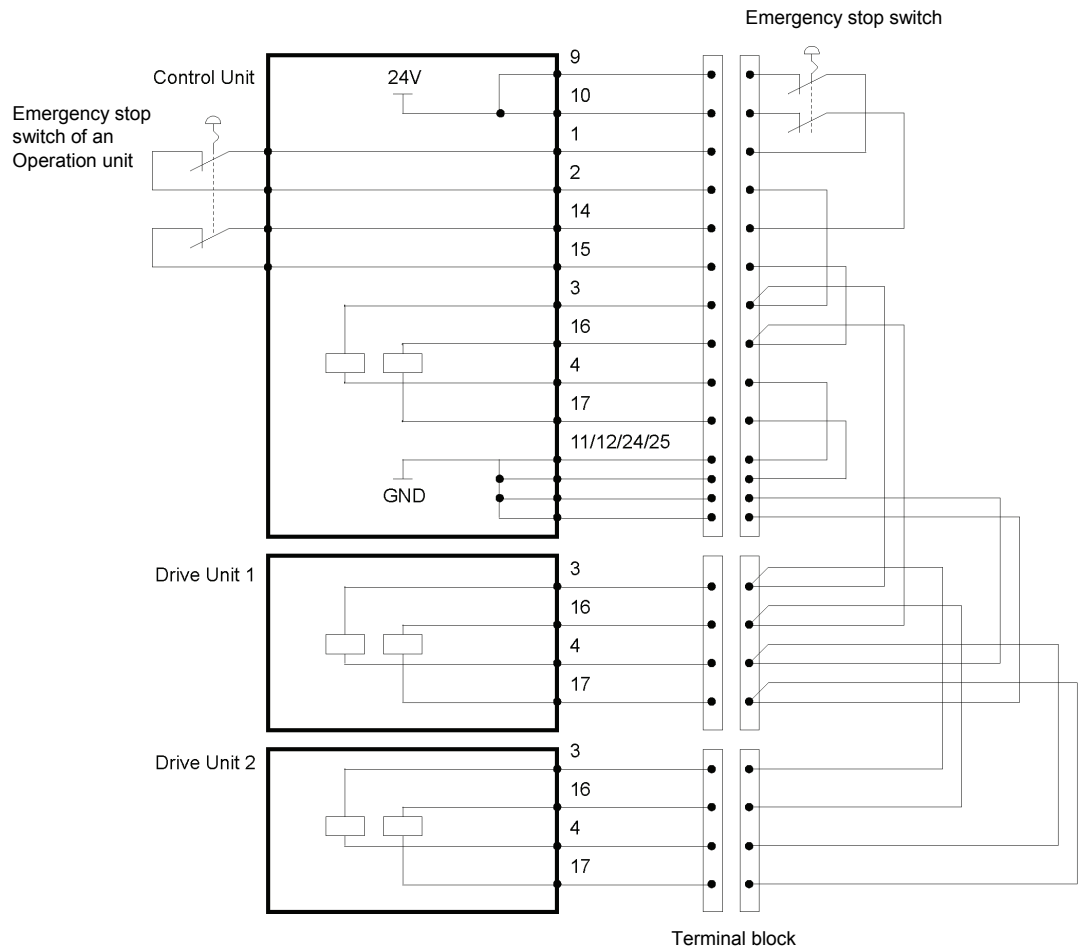

NOTE  

- The Emergency cable, Emergency cable kit, and Terminal block are offered as options.
- Design the cables connecting the units within 20 m long.

6.4.2.2 External safety relay typical application

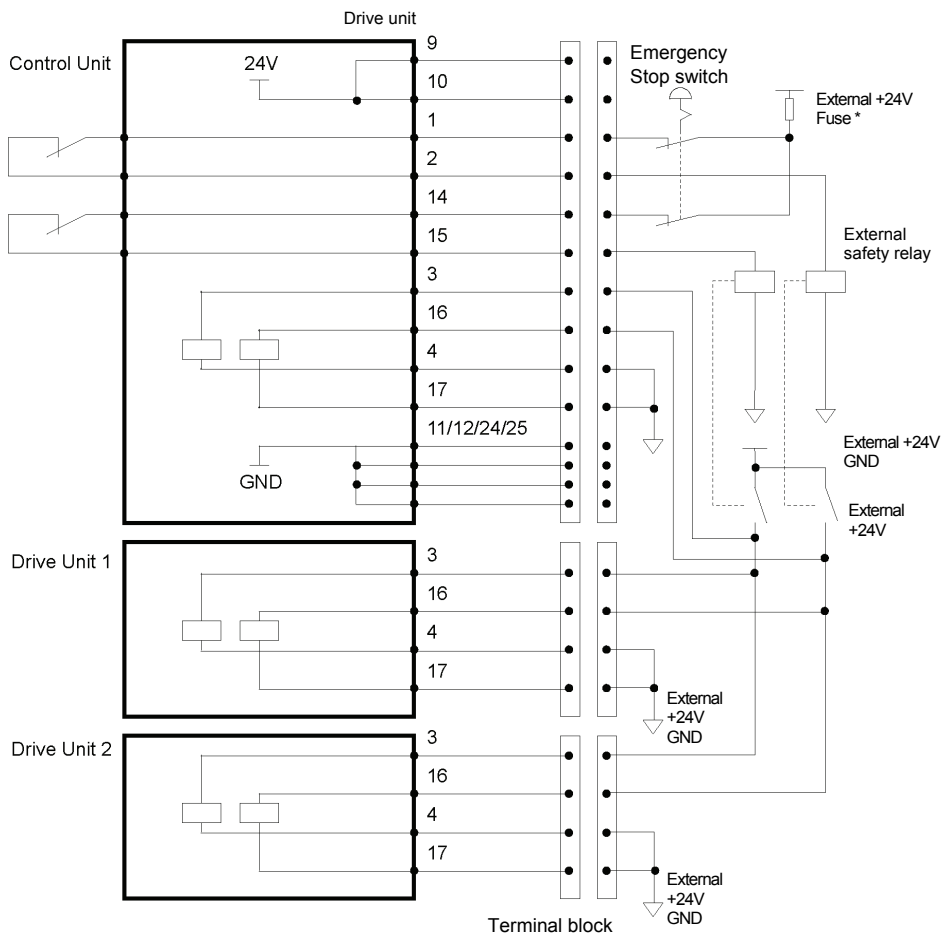

- \* Fuse
- For the protection of the emergency stop circuit, the fuse's capacity should be as follows:
  - Meets the capacity of the external
  - 0.4A or less



6.4.3 Wiring Example for Safety Door Input / Latch Release Input

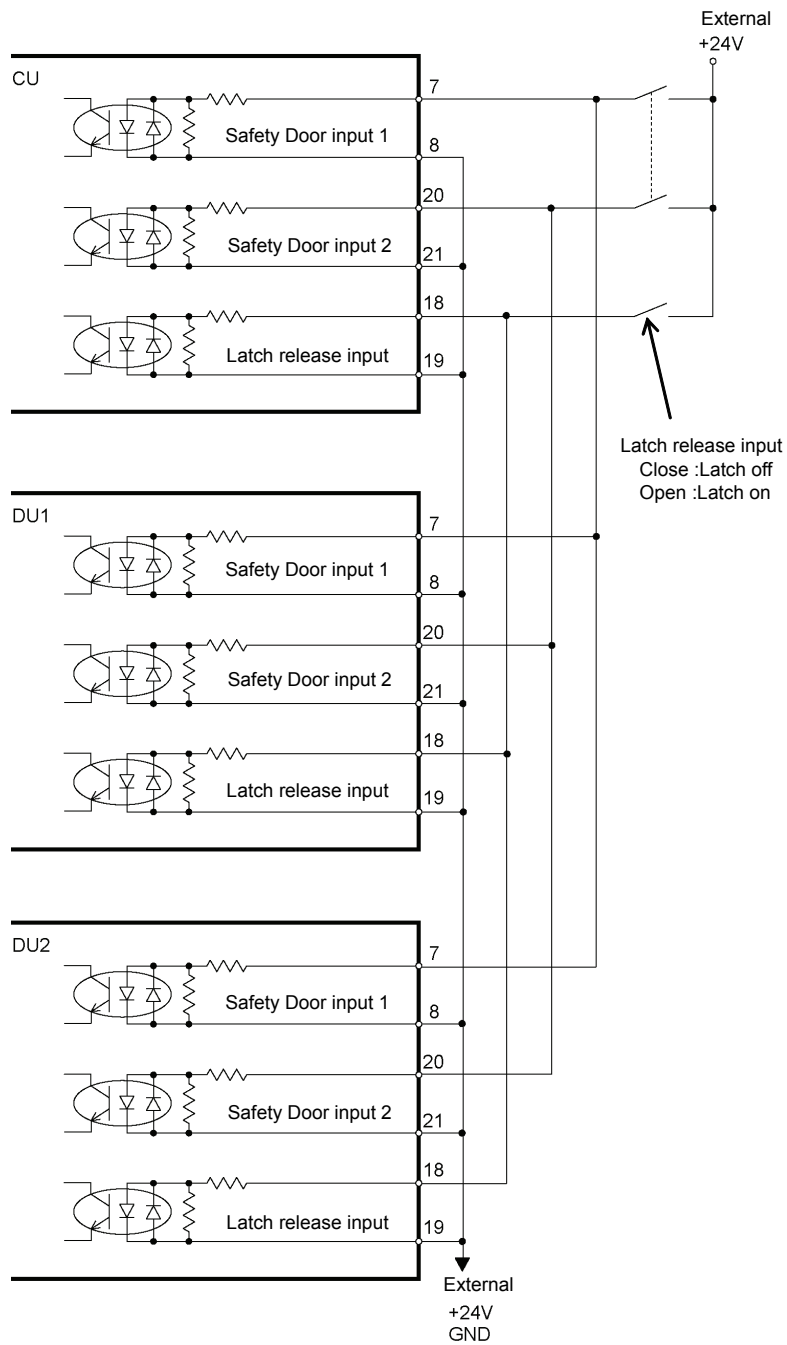

NOTE : +24V GND ▼

NOTE  

- Design the cables connecting the units within 20 m long.

# 7. I/O Connector

The I/O connector is for connecting your input/output equipment to the system.

		Pins	Bit number
Control Unit	Input	24	0 to 23
	Output	16	0 to 15
Drive Unit 1	Input	24	32 to 55
	Output	16	32 to 47
Drive Unit 2	Input	24	256 to 279
	Output	16	256 to 271

For cable wiring, refer to the *Setup & Operation 3.5 Noise Countermeasures* in order to prevent noise.

## 7.1 Input Circuit

- Input Voltage Range : +12 to 24 V  $\pm$ 10%
- ON Voltage : +10.8 V (min.)
- OFF Voltage : +5 V (max.)
- Input Current : 10 mA (TYP) at +24 V input

Two types of wiring are available for use with the two-way photo coupler in the input circuit.

### Typical Input Circuit Application 1

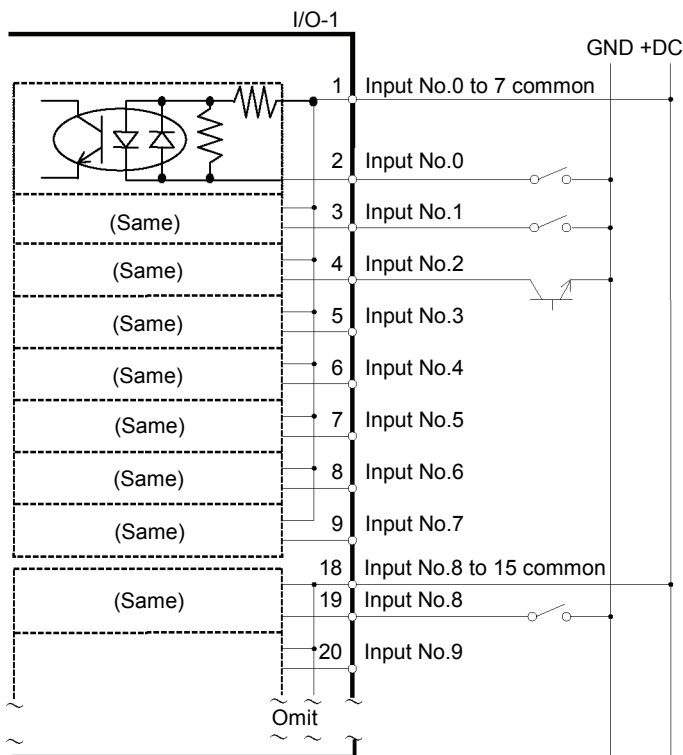

Typical Input Circuit Application 2

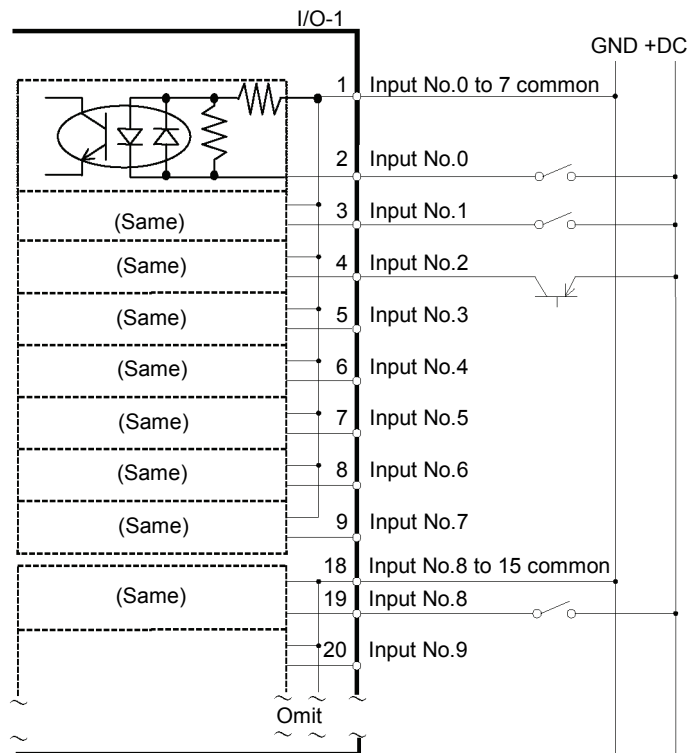

## 7.2 Output Circuit

- Rated Output Voltage : +12 V to 24 V  $\pm$ 10%
- Maximum Output Current : TYP 100 mA/1 output
- Output Driver : PhotoMOS Relay
- On-State Resistance (average) : 23.5  $\Omega$  or less

Two types of wiring are available for use with the nonpolar photoMOS relay in the output circuit.

### Typical Output Circuit Application 1

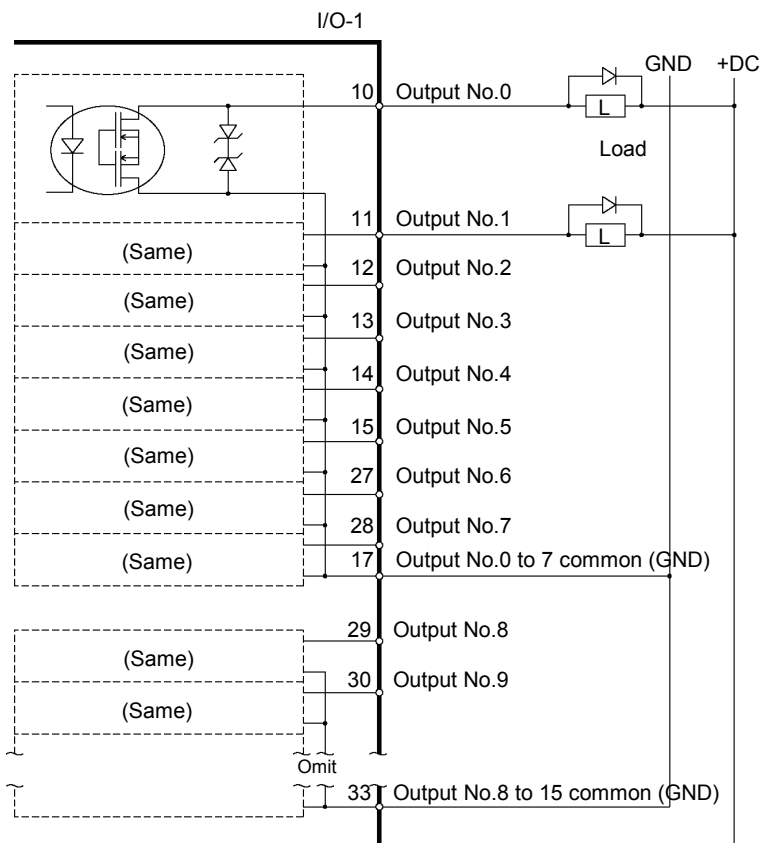

Typical Output Circuit Application 2

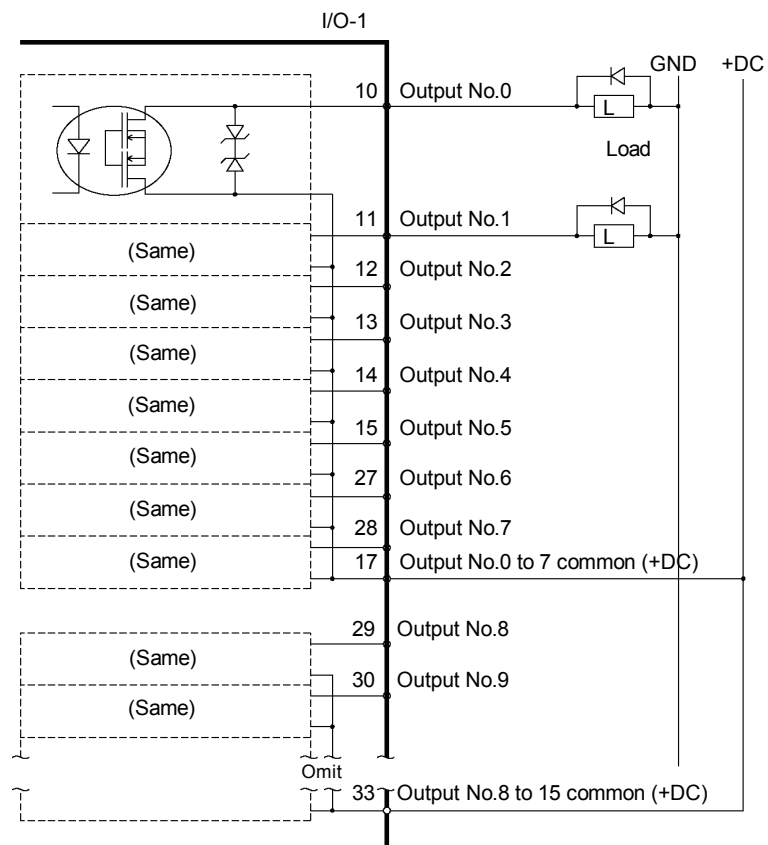

## 7.3 Pin Assignments

Pin No.	Signal Name	Pin No.	Signal Name	Pin No.	Signal Name
1	Input common No. 0 to 7	18	Input common No. 8 to 15	34	Input common No. 16 to 23
2	Input No. 0	19	Input No. 8	35	Input No. 16
3	Input No. 1	20	Input No. 9	36	Input No. 17
4	Input No. 2	21	Input No. 10	37	Input No. 18
5	Input No. 3	22	Input No. 11	38	Input No. 19
6	Input No. 4	23	Input No. 12	39	Input No. 20
7	Input No. 5	24	Input No. 13	40	Input No. 21
8	Input No. 6	25	Input No. 14	41	Input No. 22
9	Input No. 7	26	Input No. 15	42	Input No. 23
10	Output No. 0	27	Output No. 6	43	Output No.11
11	Output No. 1	28	Output No. 7	44	Output No.12
12	Output No. 2	29	Output No. 8	45	Output No.13
13	Output No. 3	30	Output No. 9	46	Output No.14
14	Output No. 4	31	Output No.10	47	Output No.15
15	Output No. 5	32	NC	48	NC
16	NC	33	Output common No. 8 to 15	49	NC
17	Output common No. 0 to 7			50	NC

Remote function is not initially assigned to both input and output. To assign the remote function, refer to *RC620 Robot Controller: Setup & Operation 11. I/O Remote Settings*.

Connector	Standard
I/O Connector (Drive Unit side)	D-sub 50 male pin Mounting style #4 - 40

\* The I/O connector, I/O connector cable, terminal block, and I/O connector kit are offered as options.

# Maintenance

This section contains maintenance procedures for the Drive unit.







# 1. Safety Precautions on Maintenance

## 1.1 Safety Precautions

 <b>WARNING</b>	<ul style="list-style-type: none"> <li>■ Only authorized personnel who have taken the safety training should be allowed to execute teaching or calibration of the robot system. The safety training is the program for industrial robot operator that follows the laws and regulations of each nation. The personnel who have taken the safety training acquire knowledge of industrial robots (operations, teaching, etc.). The personnel who have completed the robot system-training class held by the manufacturer, dealer, or locally-incorporated company are allowed to maintain the robot system.</li> <li>■ Only authorized personnel who have taken the safety training should be allowed to maintain the robot system. The safety training is the program for industrial robot operator that follows the laws and regulations of each nation. The personnel who have taken the safety training acquire knowledge of industrial robots (operations, teaching, etc.), knowledge of inspections, and knowledge of related rules/regulations. The personnel who have completed the robot system-training and maintenance-training classes held by the manufacturer, dealer, or locally-incorporated company are allowed to maintain the robot system.</li> <li>■ Make sure to use only dedicated/specified maintenance parts especially for the optional boards or any other parts in the Controller / Drive unit to be replaced. Using non-specified parts may cause serious damage to the robot system and/or serious safety problems.</li> <li>■ Do not remove any parts that are not covered in this manual. Follow the maintenance procedure strictly as described in this manual. Do not proceed using any methods other than described in this manual when you do replace a part or maintain the equipment. Improper removal of parts or improper maintenance may cause not only improper function of the robot system but also serious safety problems.</li> </ul>
---	---

 <b>WARNING</b>	<ul style="list-style-type: none"> <li>■ Before performing any maintenance procedure, always make sure that the main power of the Drive unit is turned OFF, unplug the power supply, and that the high voltage charged area is completely discharged. Performing any maintenance procedure while the main power is ON or the high voltage charged area isn't discharged completely is extremely hazardous and may result in electric shock and/or cause serious safety problems.</li> </ul>
---	---

 <b>CAUTION</b>	<ul style="list-style-type: none"> <li>■ Do not touch the Motor Driver modules, Switching Power Supply, and Regeneration Module directly in the Drive unit. The metal resistance of these can become very hot and may result in a burn. If you maintain them, examine the surface temperatures and wear protective gloves if necessary.</li> <li>■ Do not shock, shake, or drop any parts during maintenance. When the parts related with data are shocked physically, they may be damaged and may also cause data loss during data loading/saving.</li> </ul>
---	--

 CAUTION	<ul style="list-style-type: none"> <li>■ Do not lose the screws removed at maintenance. When the screw is dropped into the Drive unit, be sure to take it out. Leaving the screw in the Drive unit may cause short circuit and may result in equipment damage to the parts and/or robot system.</li> <li>■ Make sure that the power rating (wattage) of a new Motor Driver module is correct. Using a Motor Driver module with improper power rating (wattage) in the Drive unit may cause improper function of the robot system and errors.</li> <li>■ The serial number of the Manipulator that should be connected is indicated on the Connection Check Label on the Drive unit. Connect the Drive unit and the Manipulator correctly. Improper connection between the Drive unit and the Manipulator may cause not only improper function of the robot system but also serious safety problems.</li> </ul>
--	--

## 1.2 Lockout / Tagout

Lockout / tagout is a method to prevent any one from turning ON the robot system by mistake while someone else is within the safeguarded area for maintenance or repair. When performing maintenance and repair, lockout and tagout using the following procedure.

- (1) Turn OFF the POWER switch.
- (2) Secure the POWER switch mounting metal hasp in the POWER switch OFF position with screws.

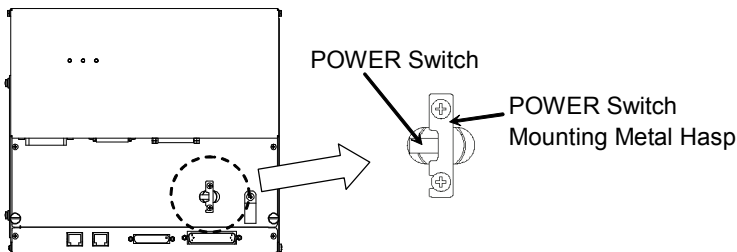

- (3) Unplug the power supply plug of the Drive unit from the power supply socket.
- (4) Attach a note to the POWER switch or the power supply plug to prevent any one from turning ON the robot system by mistake.
- (5) Lockout and tagout also for the Control Unit RC620CU.

For details, refer to the *RC620 Robot Controller: Maintenance 1.2 Lockout / Tagout*.

### RC620DU-UL:

For maintenance and repair, make sure to lockout and tagout the external disconnecting means.

## 2. Regular Maintenance Inspection

Performing regular maintenance inspection properly is essential for preventing trouble and maintaining safety. This chapter describes the schedules for maintenance inspection and procedures.

Be sure to perform the maintenance inspections in accordance with the schedules.

### 2.1 Schedule for Maintenance Inspection

Inspection points are divided into five stages: daily, monthly, quarterly, biannual, and annual. Inspection points are added at every stage.

If the robot system is operated for 250 hours or more per month, inspection points must be added every 250 hours, 750 hours, 1500 hours, and 3000 hours operation.

	Inspection Point				
	Daily inspection	Monthly inspection	Quarterly inspection	Biannual inspection	Annual inspection
1 month (250 h)	Inspect every day	✓			
2 months (500 h)		✓			
3 months (750 h)		✓	✓		
4 months (1000 h)		✓			
5 months (1250 h)		✓			
6 months (1500 h)		✓	✓	✓	
7 months (1750 h)		✓			
8 months (2000 h)		✓			
9 months (2250 h)		✓	✓		
10 months (2500 h)		✓			
11 months (2750 h)		✓			
12 months (3000 h)		✓	✓	✓	✓
13 months (3250 h)		✓			
⋮	⋮	⋮	⋮	⋮	⋮

### 2.2 Inspection Point

#### 2.2.1 Inspection While the Drive unit is Turned OFF

Inspection Point	Inspection Location	Daily	Monthly	Quarterly	Biannual	Annual
Visually check for external defects. Clean up if necessary.	External appearance of Drive unit	✓	✓	✓	✓	✓
Clean the fan filter	Fan filter on the side of the Drive unit		✓	✓	✓	✓

#### 2.2.2 Inspection While the Drive unit is Turned ON

Inspection Point	Inspection Location	Daily	Monthly	Quarterly	Biannual	Annual
Check whether unusual sound or vibration is occurring.	Entire Drive unit	✓	✓	✓	✓	✓

# 3. Drive unit Structure

## 3.1 Location of Parts

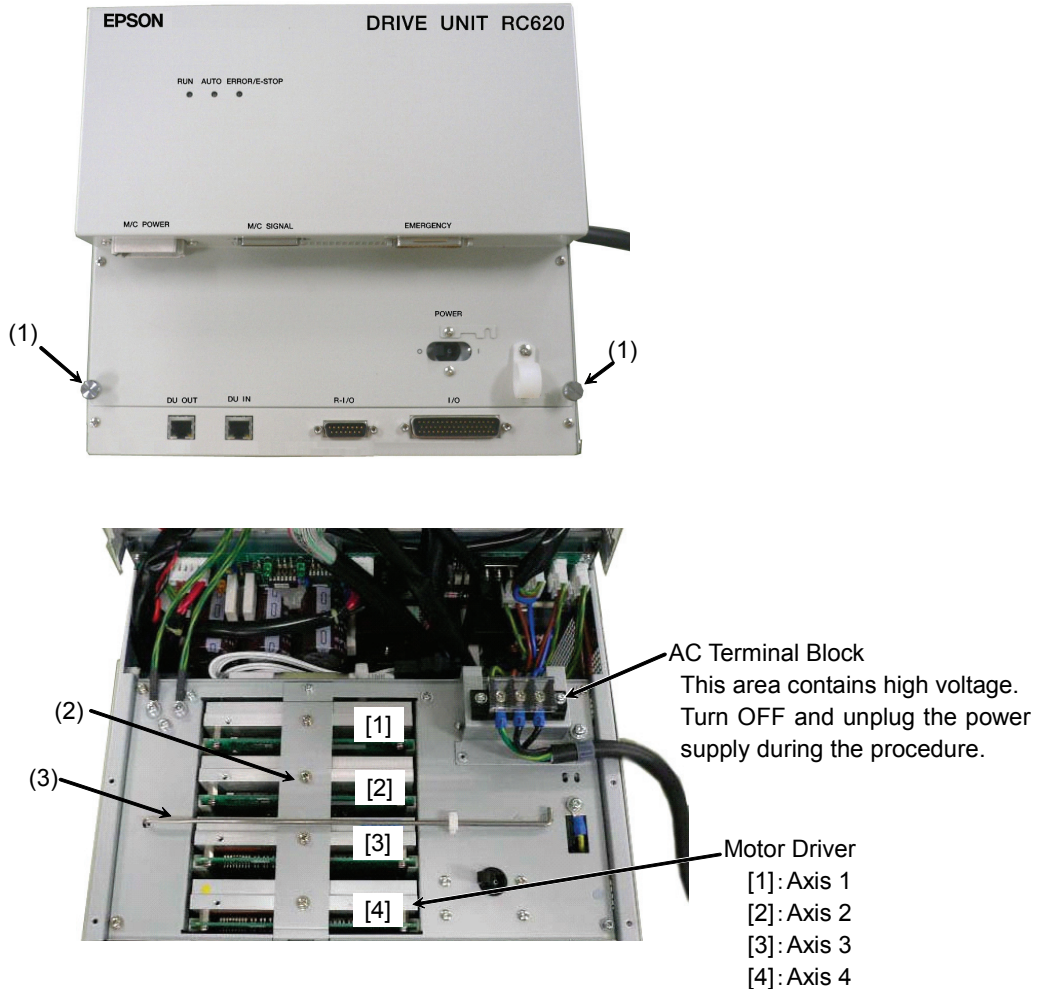

- (1) **Thumb Head screws**  
 These are two of the four screws used to mount the front cover of the Drive unit. These screws are also used to pull out the Motor Driver module and SMB unit.
- (2) **Motor Driver Mounting Bracket**  
 This is a bracket is used to secure the four motor drives. Make sure that each Motor Driver is connected properly and then mount the bracket. Improper connection may cause not only improper function of the robot system but also safety problems.
- (3) **Front Side Supporting Bar**  
 This supporting bar is used to hold the front cover open. Make sure that the supporting bar is in the proper position.

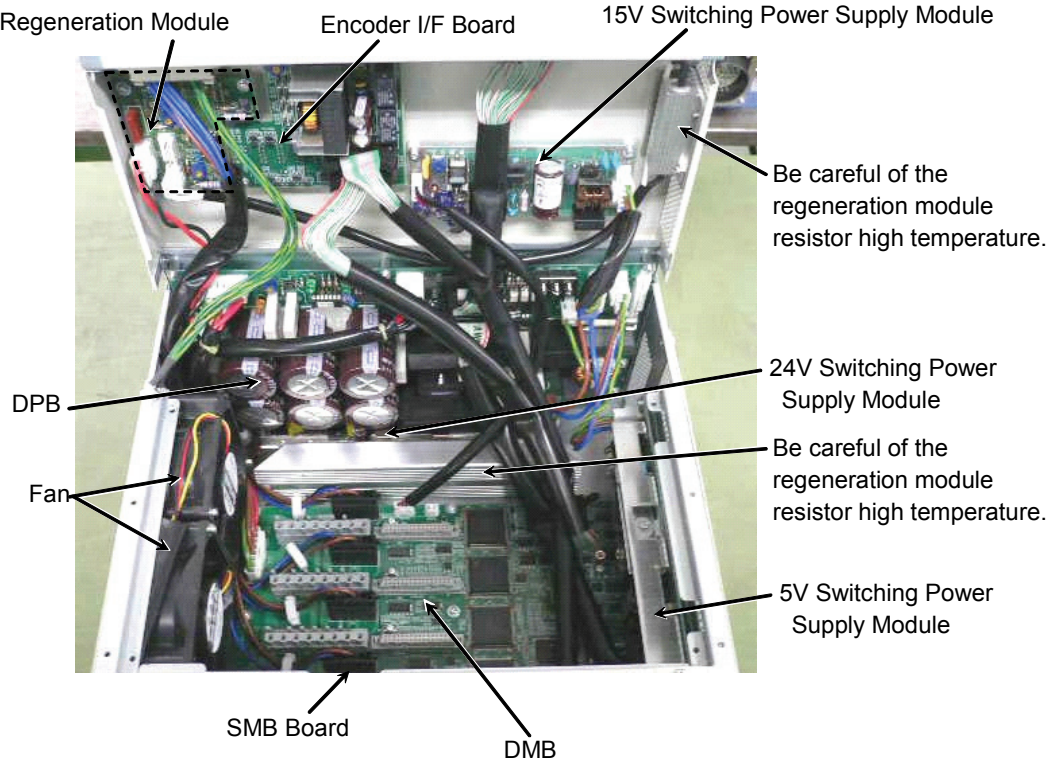

NOTE  The regeneration module is not equipped for the following manipulators:  
G1, G3

## 3.2 Diagram of Cable Connections

For the electrical connections of the Drive unit, refer to the following diagram.

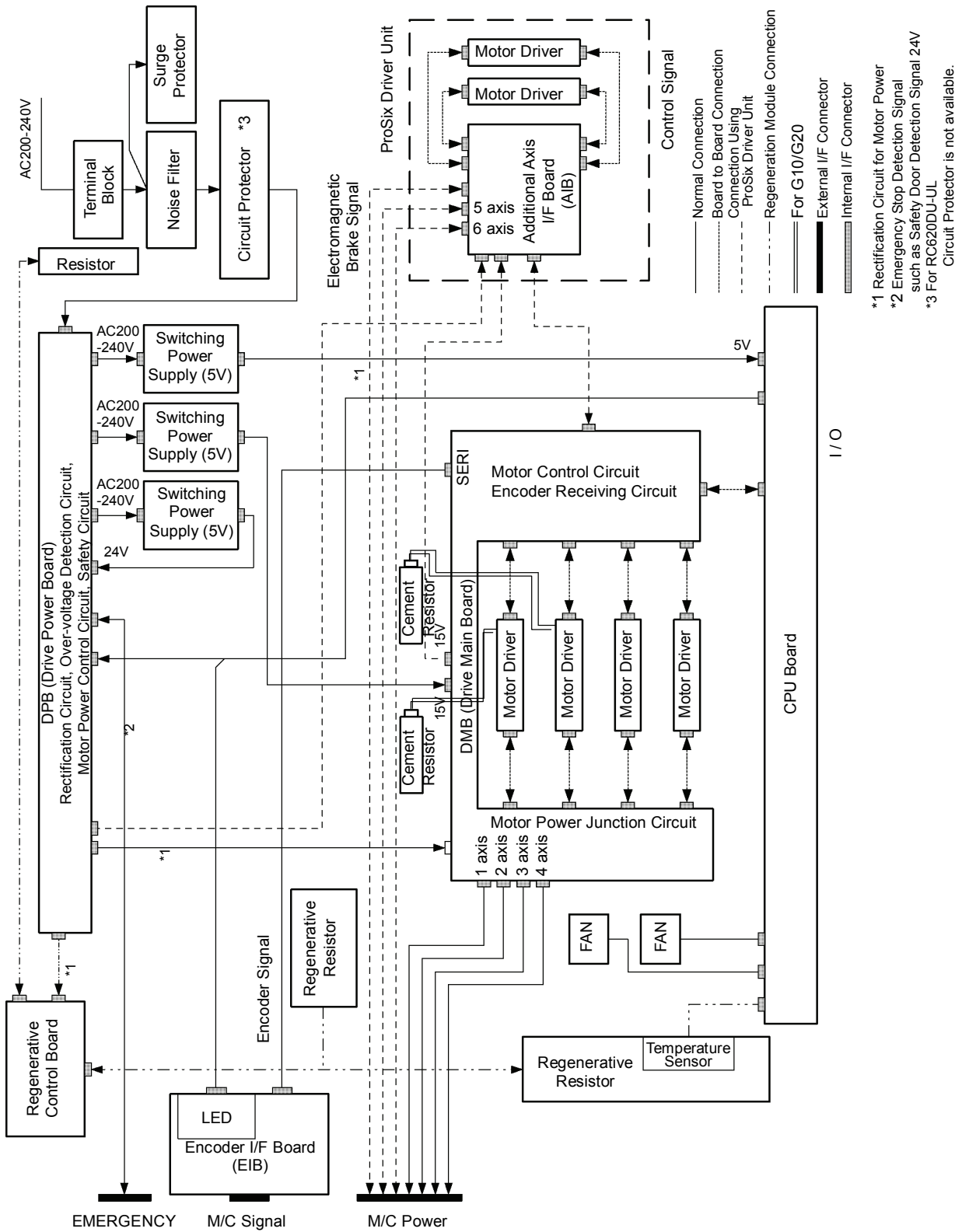





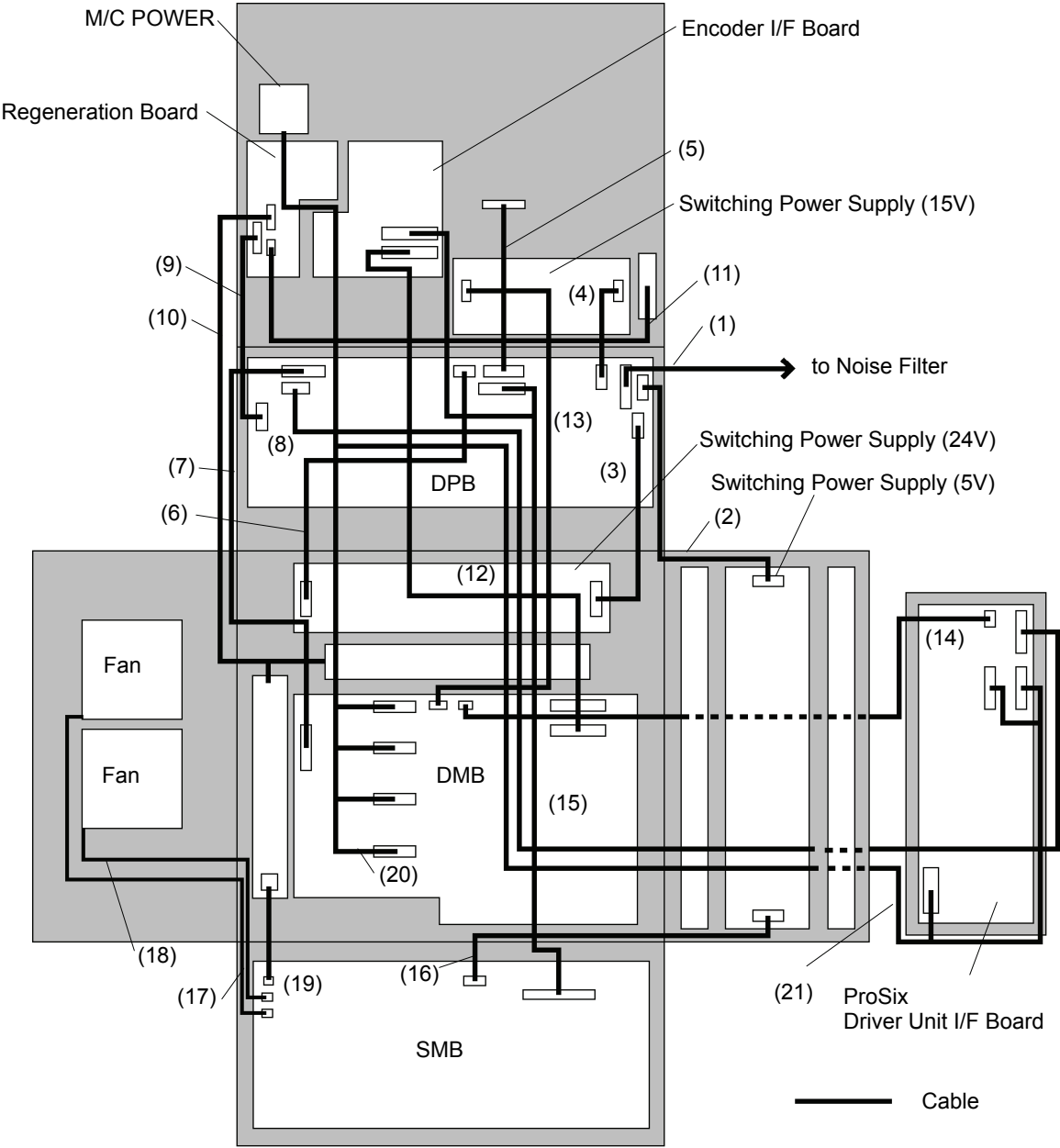

















Cable Layout Drawing

For cable connections inside the Drive unit, refer to the following figure.



This diagram is a simplified development view inside the Drive unit.  
The numbers indicated such as (1), (2), (3) correspond to the following cable list.

Cable List

Cable No.	Connection	Connector Pin Quantity	Wire Quantity	Connector Pin Quantity	Connection	Note
(1)	DPB	8 	6	–	Noise Filter	
(2)	DPB	5 	3	5 	Switching Power Supply (5V)	
(3)	DPB	5 	3	5 	Switching Power Supply (24V)	
(4)	DPB	5 	3	5 	Switching Power Supply (15V)	
(5)	DPB	26	26<F>	25(D-SUB)	EMERGENCY	
(6)	DPB	4 	4	8 	Switching Power Supply (24V)	
(7)	DPB	8 	6	8 	DMB	
(8)	DPB	5 	3	5 	ProSix Driver Unit I/F Board	*1
(9)	DPB	5 	2	5 	Regeneration Board	
(10)	Regeneration Board	4 	2	–	Regeneration Resistance	
(11)	Regeneration Board	3 	2	–	Resistance	
(12)	DMB	34	34<F>	34	Encoder I/F Board	
(13)	DMB	4 	4	4 	Switching Power Supply (15V)	
(14)	DMB	2 	2	2 	ProSix Driver Unit I/F Board	*1
(15)	DMB	50	34<F> 16<F>	34 16	DPB Encoder I/F Board	
(16)	SMB	4 	4	4 	Switching Power Supply (5V)	
(17)	SMB	3	3	–	Fan	
(18)	SMB	3	3	–	Fan	
(19)	SMB	2	2	–	Temperature Sensor	
(20)	M/C POWER	50	16	4,4,4,4	DMB	
(21)	M/C POWER	50	16 14	4,4,4,4 4,4,8	DMB ProSix Driver Unit I/F Board	*1

<F> Flat cable

\*1 When connected to ProSix Driver unit



### 3.3 Connector Pin Assignment

Pin assignments differ depending on the manipulator type.

The following tables show the pin assignments for the M/C power connector and M/C signal connector. For EMERGENCY, refer to *Setup & Operation*.

#### 3.3.1 M/C Power Connector

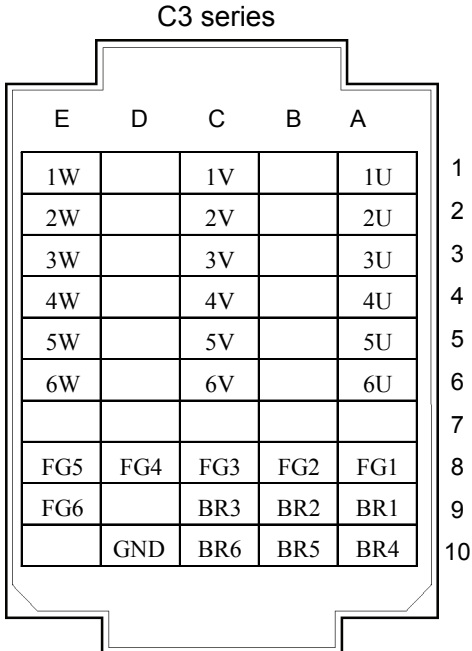
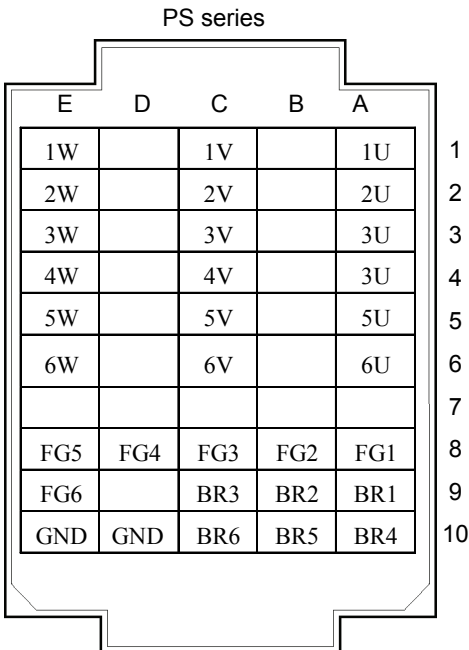
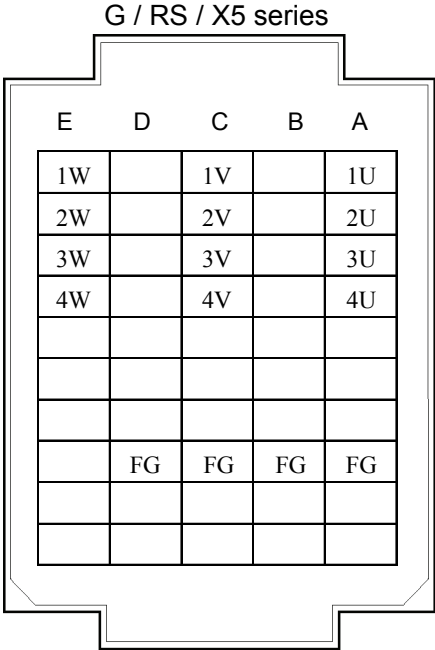

## 3.3.2 M/C Signal Connector

	PS	G / RS	C3	X5		PS	G / RS	C3	X5
1	-	-	-	ENC_GND	26	-	ENC_GND	ENC_GND	ENC_GND
2	1S+	1S+	1S+	1S+	27	1S-	1S-	1S-	1S-
3	2S+	2S+	2S+	2S+	28	2S-	2S-	2S-	2S-
4	3S+	3S+	3S+	3S+	29	3S-	3S-	3S-	3S-
5	-	ENC_5V	ENC_5V	ENC_5V	30	-	-	ENC_5V	ENC_5V
6	ENC_GND	ENC_GND	ENC_GND	ENC_GND	31	-	-	ENC_GND	ENC_GND
7	4S+	4S+	4S+	4S+	32	4S-	4S-	4S-	4S-
8	5S+	-	5S+	-	33	5S-	-	5S-	-
9	6S+	-	6S+	-	34	6S-	-	6S-	-
10	-	ENC_5V	ENC_5V	ENC_5V	35	-	-	ENC_5V	ENC_5V
11	-	ENC_GND	ENC_GND	ENC_GND	36	-	-	ENC_GND	ENC_GND
12	-	-	-	-	37	-	-	-	-
13	-	-	-	-	38	-	-	-	-
14	-	-	-	-	39	-	-	-	-
15	-	ENC_5V	ENC_5V	ENC_5V	40	-	-	-	-
16	-	ENC_GND	ENC_GND	ENC_GND	41	-	-	-	-
17	-	-	-	-	42	-	-	-	-
18	-	-	-	-	43	-	-	-	-
19	-	-	-	-	44	-	-	-	-
20	24V	ENC_5V	ENC_5V	ENC_5V	45	24V	-	-	ENC_5V
21	-	-	-	-	46	-	-	-	-
22	MPOWER	MPOWER	MPOWER	-	47	-	-	-	-
23	-	EMB_J3	-	EMB_J3	48	-	-	-	-
24	-	-	-	24V	49	24V	24V	24V	24V
25	24VGND	-	24VGND	24VGND	50	24VGND	24VGND	24VGND	24VGND

## 4. Maintenance Parts Replacement Procedures



WARNING

- Before performing any maintenance procedure, always make sure that the main power of the Drive unit is turned OFF and that the high voltage charged area is completely discharged. Performing any maintenance procedure while the main power is ON or the high voltage charged area is not discharged completely is extremely hazardous and may result in electric shock and/or cause serious safety problems.
- When opening or closing the front side, make sure that the 200 V power supply for the Drive unit is OFF. Performing procedure to the power supply terminal block inside the Drive unit while the power supply is ON is extremely hazardous and may result in electric shock and/or cause serious safety problems.

NOTE



- Be careful not to damage cables. Be sure not to drop any screws into the Drive unit.
- A spacer is used with each thumb head screw. Do not remove the spacer. Installing the front cover using a thumb head screw without a spacer may result in a cable being damaged and/or malfunction of the Drive unit.
- Installing the front cover using the wrong screws may result in a cable being damaged and/or malfunction of the Drive unit.

## 4.1 Fan and Fan Filter

Inspect the fan filter periodically and clean it when needed. The temperature inside the Drive unit may get too high and the Drive unit may not operate properly if the filter is not kept clean.

For the inspection schedule of the fan filter, refer to *Maintenance 2. Regular Maintenance Inspection*.

### 4.1.1 Cleaning and Replacing the Fan Filter

#### Fan Filter Remove

- (1) Turn OFF the Drive unit.
- (2) Pull out the two plastic fasteners indicated in the photo.

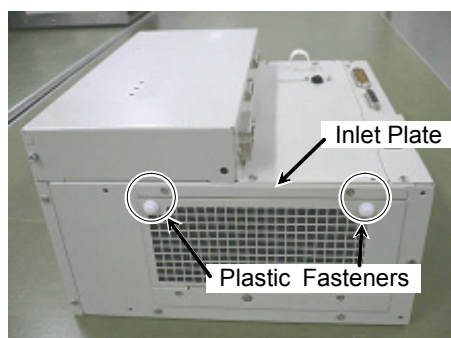

- (3) Remove the fan filter.  
Vacuum off the dust when cleaning the filter.

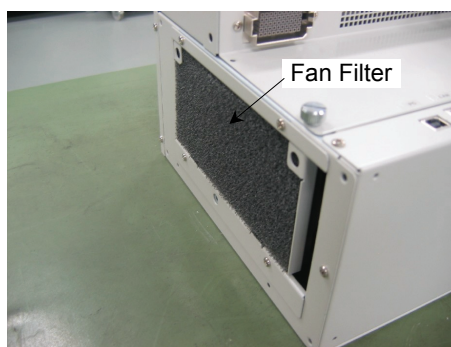

#### Fan Filter Mount

- (1) Mount the fan filter.
- (2) Insert the two flared parts of the inlet plate into the opening of the Drive unit in the direction shown by arrow (a).
- (3) Push the two plastic fasteners in the direction shown by arrow (b) until they make a clicking sound to secure the inlet plate.  
Make sure that the plate is mounted properly.

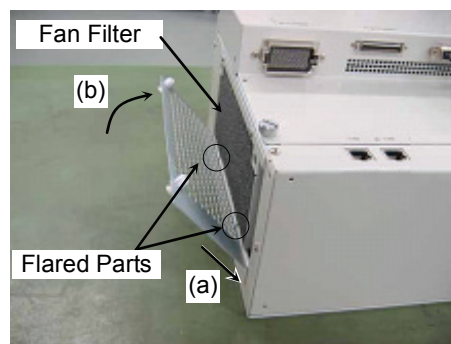

- (4) Plug in the power connector. Turn ON the Drive unit and make sure that the Drive unit starts properly without any vibration or abnormal noise.

### 4.1.2 Replacing the Fan Unit

#### Fan Unit Remove

- (1) Turn OFF the Drive unit.
- (2) Pull out the two plastic fasteners and remove the inlet plate.
- (3) Remove the four screws on the fan unit.

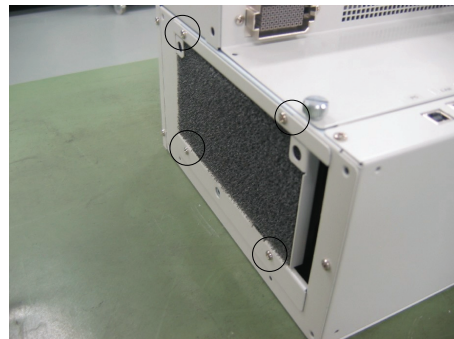

- (4) Remove the fan unit.

NOTE



The fan cable is connected to the fan unit. Be sure to remove it slowly.

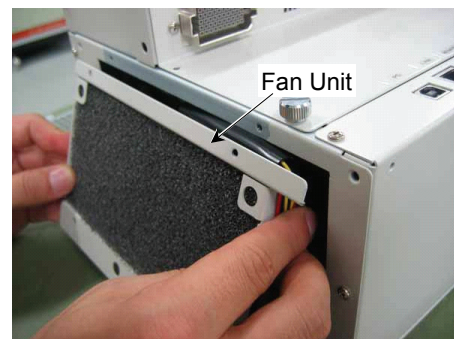

- (5) Pull out the two fan cable connectors from the SMB to the direction shown by the arrow.

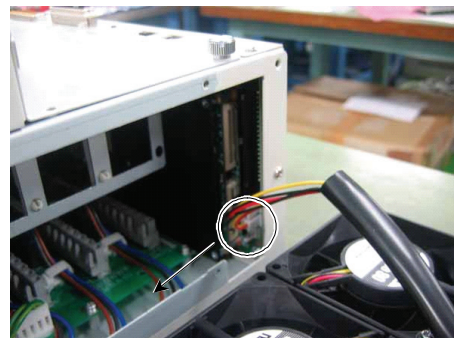

- (6) Remove the fan filter from the fan unit.

NOTE



When the Option Unit is mounted, the fan filter is not used.

Fan Unit Mount

- (1) Mount a new fan filter in the fan unit.



NOTE When an Option Unit is mounted, no fan filter is necessary.

- (2) Connect the two fan cable connectors to the CPU board.

Refer : *Maintenance 3.2 Diagram of Cable Connections - Cable Layout Drawing*

- (3) Hold down the fan cable protection tube as shown in the photo and install the fan unit to the Drive unit.



NOTE Be sure to keep the Drive unit cable from being trapped between the DPB and the fan.

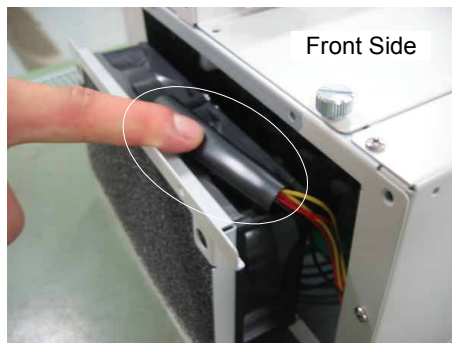

- (4) Secure the fan unit to the main chassis with four screws.

- (5) Insert the two flared parts of the inlet plate into the opening of the Drive unit in the direction shown by arrow (a).

- (6) Push in the two plastic fasteners in the direction shown by arrow (b) until they make a clicking sound to mount the inlet plate.

Make sure that the plate is mounted properly.

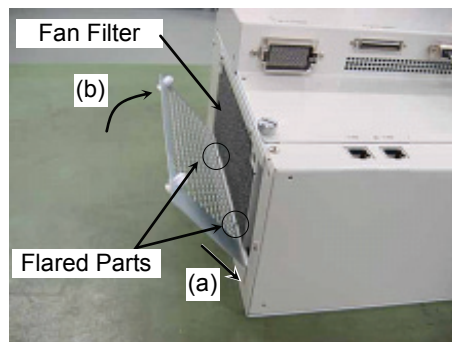

- (7) Plug in the power connector. Turn ON the Drive unit and make sure that the Drive unit starts properly without any vibration or abnormal noise.

## 4.2 Motor Driver

### 4.2.1 Part Names

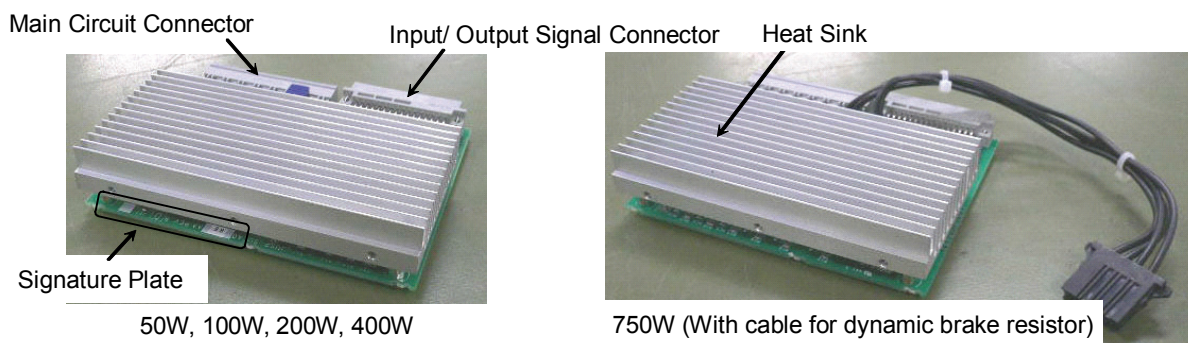

The wattage of the motor driver can be determined by the type code indicated on the signature plate. The wattage of the installed motor driver corresponds with the wattage of the driving motor.

Type	Wattage
JUSP-SU021A*	50 W
JUSP-SU028A*	100 W
JUSP-SU065A*	200 W
JUSP-SU085A*	400 W
JUSP-SU169A*	750 W

\* The asterisk indicates one alphanumeric character.

### 4.2.2 Replacing the Motor Driver (Axis 1 to 4)



**WARNING**

- Be sure to record the type and the power rating (wattage) setting of the current Motor Driver to set the correct power rating (wattage) when replacing the Motor Driver.

Using a Motor Driver with improper power rating (wattage) in the Drive unit will cause improper function of the robot system.

Motor Driver  
(Axis 1 to 4)  
Remove

- (1) Turn OFF the Drive unit and unplug the power connector.
- (2) Disconnect the following cables from the front side of the Drive unit.
  - M/C Power Cable
  - M/C Signal Cable
  - EMERGENCY Cable
- (3) Remove the four screws shown in the photo.

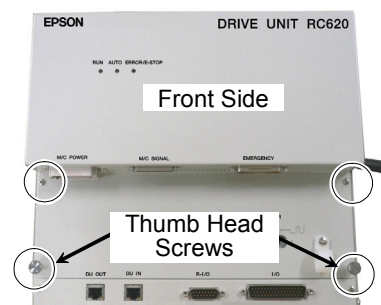

**NOTE** The thumb head screws are used to pull out the Motor Driver.

(4) Loosen the two screws on the side of the front side.

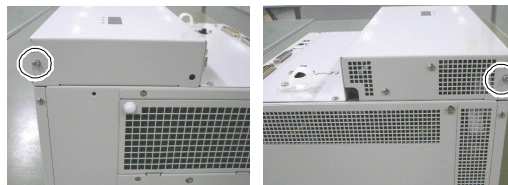

(5) Open the front cover and hold it open.

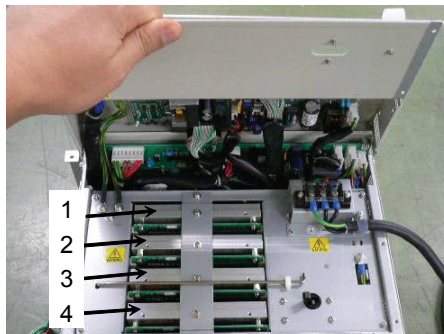

Motor Driver  
 1: Axis 1  
 2: Axis 2  
 3: Axis 3  
 4: Axis 4

(6) Open the clamp for the front cover support bar.



Push the latch A shown in the photo first and then open the clamp.

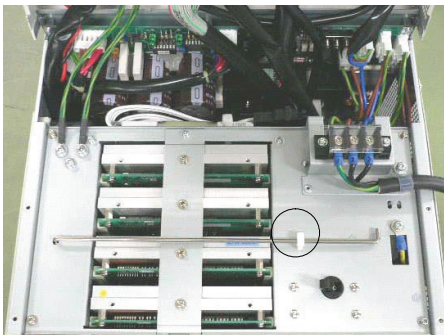
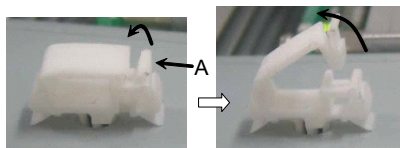

(7) Insert the top of the support bar into the support hole as shown without moving the base point.

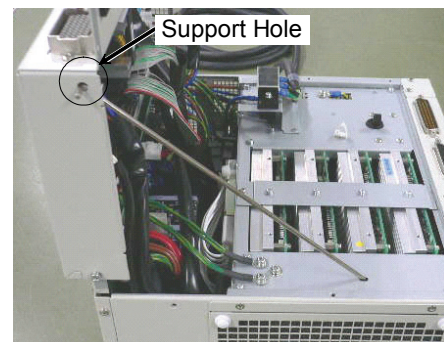
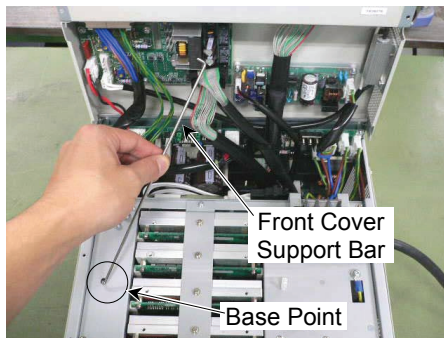



- (8) Remove the five screws from the Motor Driver mounting bracket.

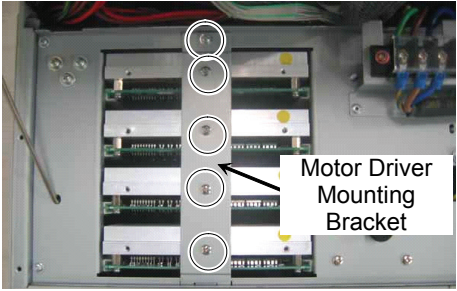

Connected to the G10 or G20 series manipulator  
 Refer to Remove step (9) and remove the connector.

Connected to the G1, G3, G6, PS, C3, RS or X5 series manipulator  
 Go on to Remove step (10).

- (9) When replacing the first or the second motor driver, compress both ends of the connector connected to the driver to pull out the connector.  
 (Remove the connector connected to the replacing motor driver.)

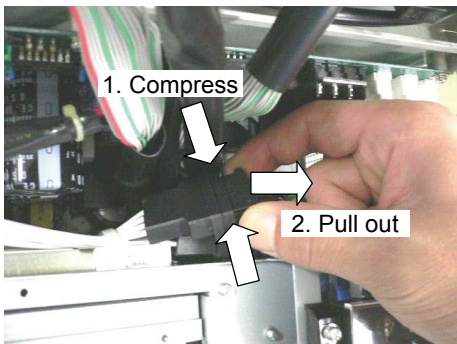
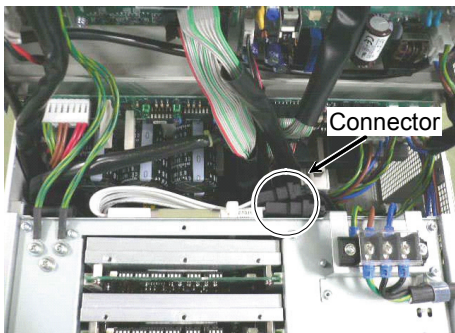

- (10) Secure the two thumb head screws removed in step (3) to the Motor Driver heat sink.  
 Pull out the Motor Driver by pulling the two thumb head screws together evenly.



NOTE  

When using the G10 or G20 series manipulator, a cable and a connector are connected to the first and the second motor driver.  
 When removing the motor driver, make sure to keep the connector from being stuck.

 CAUTION	<ul style="list-style-type: none"> <li>■ Be careful not to cut your fingers.                      The Motor Driver connector may be connected tightly. The connector may be disconnected suddenly by a strong pull and may cause your fingers to be cut by the Motor Driver heat sink.</li> </ul>
--	---

Motor Driver  
(Axis 1 to 4)  
Mount

Connected to the G10 or G20 series manipulator  
Start from Mount step (1).

Connected to the G1, G3, G6, PS, C3 , RS or X5 series manipulator  
Start from Mount step (3).

- (1) When replacing the first or the second motor driver, insert the connector connected to the motor driver carefully along the guide rail through the rear side of the intermediate plate

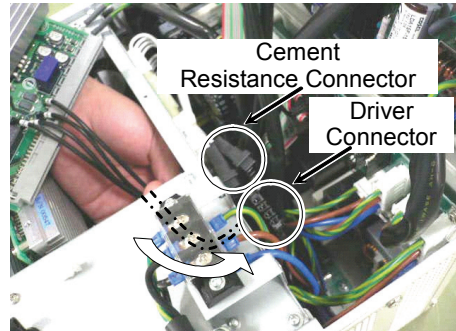

- (2) Connect the connector connected to the replacing first or second motor driver to the cement resistance connector.



There are two cement resistance connectors. The connector for the motor driver can be connected to either one of them. Connect to the resistance connector in the easier position.

- (3) Insert the Motor Driver along the guide rails until the surface height differences of the Motor Driver comes to 5 mm or less.

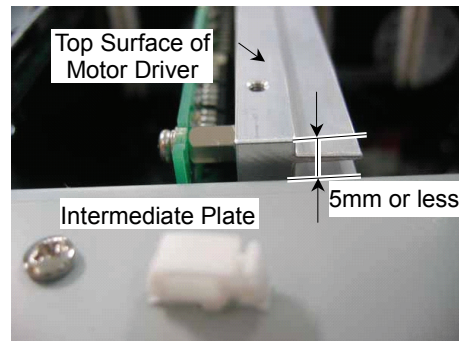

- (4) Push the Motor Driver securely into the two Motor Driver connectors.

- (5) Secure the Motor Driver mounting bracket with five screws.
- (6) Hold the front cover and put the front cover support bar back to the normal position.

- (7) Secure the front cover support bar with the clamp.



Push latch A as shown in the photo first and open the clamp.

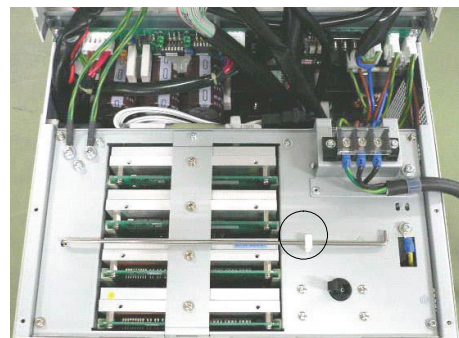
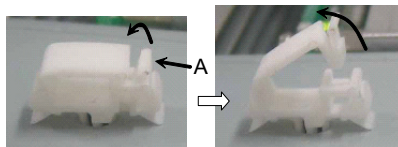

- (8) Secure the two screws on the side of the front cover.
- (9) Close the front cover and secure it with four screws.



Make sure to keep cables from becoming trapped or damaged.

- (10) Connect the following cables if they were previously connected to the front of the Drive unit.
- M/C Power Cable
  - M/C Signal Cable
  - EMERGENCY Cable
- (11) Plug in the power connector. Turn ON the Drive unit and make sure that the Drive unit starts properly without any vibration or abnormal noise.

4.2.3 Replacing Motor Driver (Axis 5 and 6)

Motor Driver  
(Axis 5 and 6)  
Remove

- (1) Turn OFF the Drive unit and unplug the power connector.
- (2) Open the front cover.  
Refer : *Maintenance 4.2.2 Replacing Motor Driver (Axis 1 to 4)*  
*Removing procedure from (2) to (7)*

- (3) Remove the four screws shown to remove the top cover of the ProSix Driver Unit.

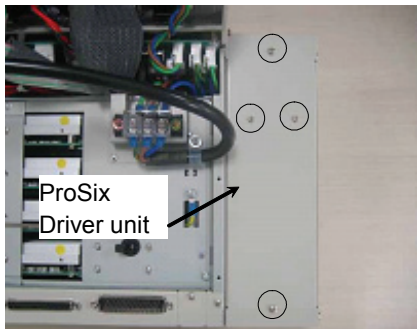

- (4) Remove two screws to remove the Motor Driver mounting bracket.

Motor Driver  
5: Axis 5  
6: Axis 6

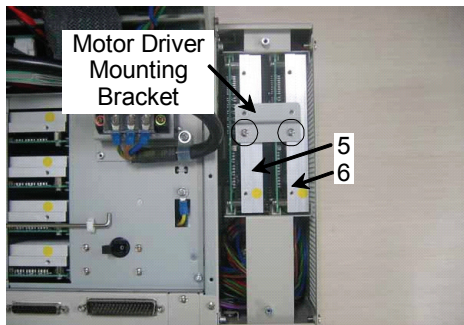

- (5) Secure the two thumb head screws removed in step (2) to the Motor Driver heat sink as shown.



- (6) Pull out the Motor Driver by pulling the two thumb head screws together evenly.



■ Be careful not to cut your fingers.  
The Motor Driver connector may be connected tightly. The connector may be disconnected suddenly by a strong pull and may cause your finger to be cut by the Motor Driver heat sink.

Motor Driver  
(Axis 5 and 6)  
Mount

- (2) Insert the Motor Driver along the guide rails until the surface height differences of the Motor Driver comes to 5 mm or less.
- (3) Push the Motor Driver securely into the two Motor Driver connectors.

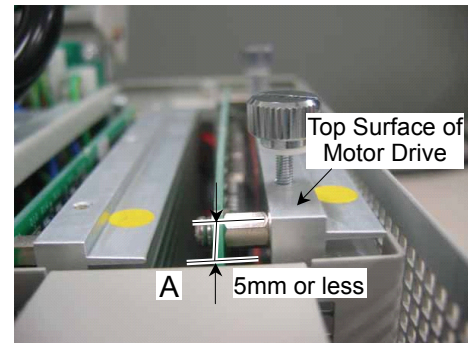

- (4) Secure the Motor Driver mounting bracket with two screws.
- (5) Secure the top cover of the ProSix Driver Unit with four screws.
- (6) Close the front side.  
Refer : *Maintenance 4.2.2 Replacing Motor Driver (Axis 1 to 4)*  
*Mounting procedure from (5) to (9)*
- (7) Plug in the power connector. Turn ON the Drive unit and make sure that the Drive unit starts properly without any vibration or abnormal noise.

### 4.3 SMB Unit

**NOTE**  The Drive unit differs by the using manipulator. Different procedures are instructed for each Drive unit as follows. Follow the corresponding procedure.

- Connected to the PS or C3 series manipulator
- Connected to the G, RS or X5 series manipulator

**SMB Unit Remove**

- (1) Turn OFF the Drive unit and unplug the power connector.
- (2) Disconnect the cables connected to the SMB.  
DU OUT DU IN (R-I/O) I/O
- (3) Remove four screws on the front cover and three screws on the backside shown in the photo.

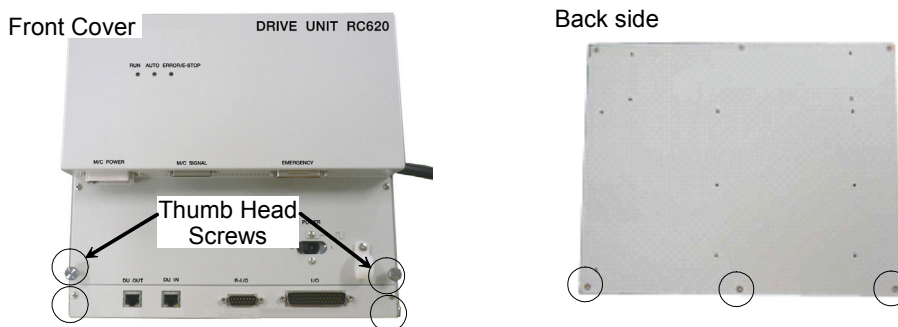

Connected to the PS or C3 series manipulator  
Perform steps (4) to (6) to remove the ProSix Driver Unit.

Connected to the G, RS or X5 series manipulator  
Go on to step (7).

- (4) Remove the screw on the top and bottom to remove the two covers.



- (5) Remove two screws on each cover.



- (6) Slide the ProSix Driver Unit approximately 20 mm in direction (A) and then slowly slide it approximately 10 mm in direction (B).



The ProSix Driver Unit cable is connected to the main chassis. Be sure to remove it slowly.

The DMB of the ProSix Driver Unit is connected to the board connector.

Be sure to slide the ProSix Driver Unit straight out in direction (A) as shown.

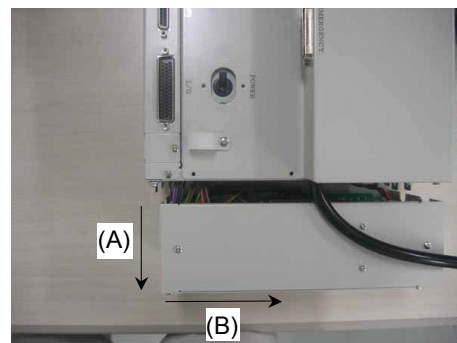

- (7) Remove the screws on both sides of the SMB unit.

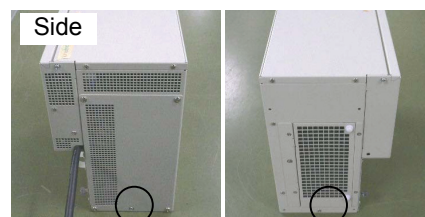

- (8) Install the two thumb head screws removed in step (3) in the SMB unit.

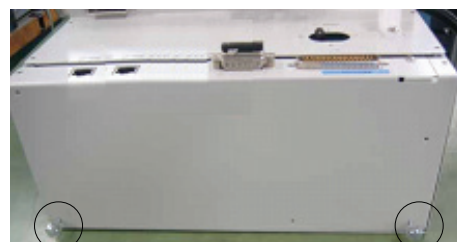

- (9) Hold the thumb head screws and pull the SMB unit straight out.



The SMB unit cable is connected to the main chassis. Be sure to remove slowly.

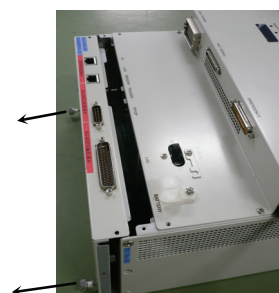

- (10) Disconnect the four connectors connected to the SMB.  
Refer : *Maintenance 3.2 Diagram of Cable Connections - Cable Layout Drawing*

SMB Unit  
Mount

- (1) Connect the four CPU board connectors.  
Refer : *Maintenance 3.2 Diagram of Cable Connections*  
- *Cable Layout Drawing*

- (2) Carefully insert the SMB by pushing it straight in.



- Make sure that connector CN2 of the SMB and the DMB connector (CPU IF) are connected when inserting the Unit.
- Be sure to keep the cable from being trapped or damaged.

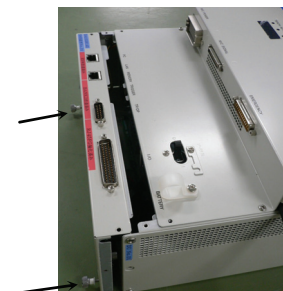

- (3) Mount the screw on each side of the SMB.

Connected to the PS or C3 series manipulator  
Perform steps (4) to (6) to secure the ProSix Driver Unit.

Connected to the G, RS or X5 series manipulator  
Move on to step (7).

- (4) Insert the ProSix Driver Unit into the position.



- Refer to the photo and be sure to position the mounting bracket properly as shown.



- (5) Secure the ProSix Driver Unit with two screws on the top and bottom.
- (6) Secure the two covers with a screw of the top and bottom.
- (7) Secure each cover with the screws.  
(Front cover : 4 screws, Backside : 3 screws)
- (8) Connect the following cables to the SMB.  
DU OUT    DU IN    (R-I/O)    I/O
- (9) Plug in the power connector. Turn ON the Drive unit and make sure that the Drive unit starts properly without any vibration or abnormal noise.



## 5. Checklist for Contact

In case that you have any trouble, please copy the next page and fax us after filling in.

Then, we will study the report and contact you with the countermeasures.

**FAX 0266-61-1846**

Factory Automation Systems Department  
SEIKO EPSON CORPORATION  
TEL 0266-61-1813

## Trouble Occurrence Report (RC620 Robot Controller)

Company name :	Trouble occurrence date : YY MM DD
Reported by :	TEL : (Extension )
Contact personnel :	FAX :
Controller : Control Unit - RC620 CU Drive Unit - RC620 DU	Manipulator model :
Controller S/N. : S/N.	Manipulator S/N. : S/N.

Detail:

1. Can you describe the symptoms? (Noise, Vibration, etc.)
  
2. When is it happening? (During the boot, operation, command execution, etc.)
  
3. How often is it happening? (Every time, once an hour, etc.)
  
4. How is the LED status of RC620 Control Unit?  
TEACH / AUTO / PROGRAM
 

TEACH AUTO PROGRAM
  
5. How is the LED status of RC620 Drive Unit?  
RUN / AUTO / ERROR/E-STOP
 

RUN AUTO ERROR/E-STOP
  
6. Please check the Error History
  
7. Others

Thank you very much.

## 6. Maintenance Parts List

Part Name		Code	Note
Fan Unit		R13B060501	
Fan Filter		R13B060502	For Base Unit
Motor Driver	50 W	R13B070101	
	100 W	R13B070102	
	200 W	R13B070103	
	400 W	R13B070104	
	750 W	R13B070105	
Fuse		R13B060401	For DPB
SMB Unit		R13B040008	
Controller Mounting Metal Hasp	(L)	R13B071302	
	(S)	R13B071303	
Connecting cable	1.5 m	R13B020213	For RC620DU
	3 m	R13B020214	
	5 m	R13B020215	
	10 m	R13B020216	

